

JVC

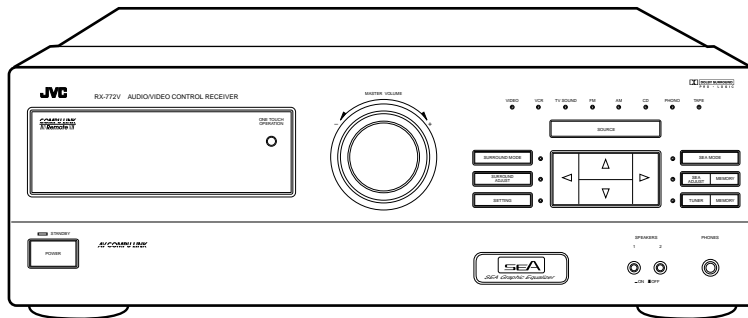

AUDIO/VIDEO CONTROL RECEIVER

RX-772VBK

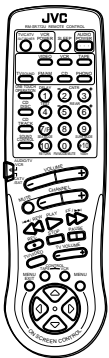

COMPU LINK
/// Remote ///

AV COMPU LINK

INSTRUCTIONS

For Customer Use:

Enter below the Model No. and Serial No. which are located either on the rear, bottom or side of the cabinet. Retain this information for future reference.

Model No. _____

Serial No. _____

LET0052-001A

[J]

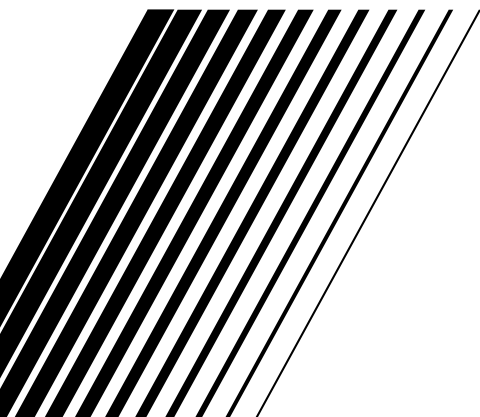

Warnings, Cautions and Others

	CAUTION RISK OF ELECTRIC SHOCK DO NOT OPEN	
CAUTION: TO REDUCE THE RISK OF ELECTRIC SHOCK. DO NOT REMOVE COVER (OR BACK) NO USER SERVICEABLE PARTS INSIDE. REFER SERVICING TO QUALIFIED SERVICE PERSONNEL.		

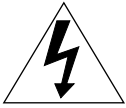

The lightning flash with arrowhead symbol, within an equilateral triangle is intended to alert the user to the presence of uninsulated "dangerous voltage" within the product's enclosure that may be of sufficient magnitude to constitute a risk of electric shock to persons.



The exclamation point within an equilateral triangle is intended to alert the user to the presence of important operating and maintenance (servicing) instructions in the literature accompanying the appliance.

CAUTION

To reduce the risk of electrical shocks, fire, etc.:

1. Do not remove screws, covers or cabinet.
2. Do not expose this appliance to rain or moisture.

Caution — POWER switch!

Disconnect the mains plug to shut the power off completely. The POWER switch in any position does not disconnect the mains line. The power can be remote controlled.

Caution — SPEAKER LOAD SELECTOR switch!

Match the position of SPEAKER LOAD SELECTOR switch on the back panel to the impedance of the speaker connected, to protect from overheating.

WARNING: TO REDUCE THE RISK OF FIRE OR ELECTRIC SHOCK, DO NOT EXPOSE THIS APPLIANCE TO RAIN OR MOISTURE.

Once you have found the best Surround settings for your listening room, note them in the table below for future reference (even though the receiver memorizes the settings until you change them).

For actual setting procedures, see pages 24 to 30.

Surround Mode	Hall Surround	Dolby Pro Logic	Dolby 3ch Logic
Center Mode	_____	WIDE NORMAL PHANTOM OFF	WIDE NORMAL OFF
Delay Time	DELAY 1 DELAY 2 DELAY 3 DELAY 4	DELAY 1 DELAY 2 DELAY 3 DELAY 4	_____
Center Speaker Level	_____		
Rear Speaker Level			_____
Center Tone	_____	SOFT2 SOFT1 FLAT SHARP1 SHARP2	SOFT2 SOFT1 FLAT SHARP1 SHARP2

Getting Started	2
Before Installation	2
Checking the Supplied Accessories	2
Switches, Buttons and Controls	3
Connecting the FM and AM Antennas	5
Connecting the Speakers	6
Connecting Audio/Video Components	8
Connecting the Power Cord	10
Putting Batteries in the Remote Control	10
Basic Operations	11
Turning the Power On and Off	11
Selecting the Source to Play	11
Adjusting the Volume	12
Selecting the Front Speakers	12
Muting the Sound	13
Recording a Source	13
Basic Settings	14
Adjusting the Front Speaker Output Balance	14
Listening at Low Volume (Loudness)	14
Using the Sleep Timer	15
Selecting the Center Speaker Size	16
Using Visual Confirmation	17
One Touch Operation	18
About the One Touch Operation	18
Using the One Touch Operation	18
Receiving Radio Broadcasts	19
Tuning in Stations Manually	19
Using Preset Tuning	19
Selecting the FM Reception Mode	20
Assigning Names to Preset Stations	21
Using the SEA Modes	22
Selecting Your Favorite SEA Mode	22
Creating Your Own SEA Mode	23
Using the Surround Processor	24
Using JVC's Hall Surround	24
Speaker arrangements for Dolby Surround	26
Preparing for Dolby Surround	27
Using Dolby Surround	30
Using the On-Screen Display to Control the Receiver	31
COMPU LINK Remote Control System	35
AV COMPU LINK Remote Control System	36
Using the Remote Control for Operating JVC's Audio/Video Components	38
Operating Other Manufactures' VCR, TV, CATV Converter, and Satellite Tuners	40
Troubleshooting	46
Specifications	47



This mark indicates that you can also use the menu function to do the same operations. Actual operations using the menu function are explained on the pages indicated next to the marks.

Getting Started

This section explains how to connect audio/video components and speakers to the receiver, and how to connect the power supply.

Before Installation

General

- Be sure your hands are dry.
- Turn the power off to all components.
- Read the manuals supplied with the components you are going to connect.

Locations

- Install the receiver in a location that is level and protected from moisture.
- The temperature around the receiver must be between 23° and 95° F (–5° and 35° C).
- Make sure there is good ventilation around the receiver. Poor ventilation could cause overheating and damage the receiver.

Handling the receiver

- Do not insert any metal object into the receiver.
 - Do not disassemble the receiver or remove screws, covers, or cabinet.
 - Do not expose the receiver to rain or moisture.
-

Checking the Supplied Accessories

Check to be sure you have all of the following items, which are supplied with the receiver. The number in the parenthesis indicates the quantity of the pieces supplied.

- **Remote Control (1)**
- **Batteries (2)**
- **AM Loop Antenna (1)**
- **FM Antenna (1)**

If anything is missing, contact your dealer immediately.

Become familiar with the main switches and controls on your receiver before use.

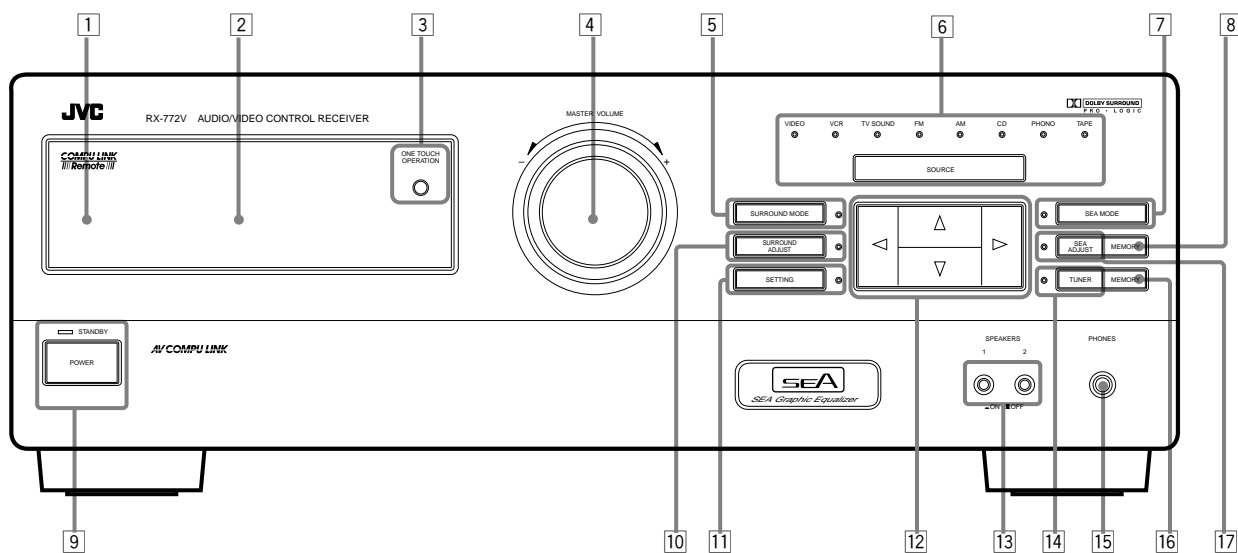

Refer to the pages in parentheses for details.

Front Panel

- 1 Remote sensor (10)
- 2 Display (11)
- 3 ONE TOUCH OPERATION button and lamp (18)
- 4 MASTER VOLUME control (12)
- 5 SURROUND MODE button and lamp (24, 27)
- 6 SOURCE button and lamps (11)
- 7 SEA MODE button and lamp (22)
- 8 MEMORY button for SEA adjustments (23)
- 9 POWER button and STANDBY lamp (11)
- 10 SURROUND ADJUST button and lamp (25, 27)
- 11 SETTING button and lamp (14 to 17)
- 12 Control $\Delta / \nabla / \triangleleft / \triangleright$ buttons
- 13 SPEAKERS 1/2 buttons (12)
- 14 TUNER button and lamp (19)
- 15 PHONES jack (13)
- 16 MEMORY button for presetting channels (19)
- 17 SEA ADJUST button and lamp (23)

IMPORTANT

To use Control $\Delta / \nabla / \triangleleft / \triangleright$ buttons (12) on the front panel:

What these buttons actually do depends on which function you are trying to adjust. Before using these buttons, select the function by pressing one of **the function selecting buttons** (5, 6, 7, 10, 11, 14, 17), and being sure its lamp is lit.

However, pressing MENU (33 on the remote control) overrides the selected function and causes Control $\Delta / \nabla / \triangleleft / \triangleright$ button to act like $\Delta / \nabla / \triangleleft / \triangleright$ buttons (34) of the ON SCREEN CONTROL section of the remote control (though a lamp for the selected function remains lit).

To return the Control $\Delta / \nabla / \triangleleft / \triangleright$ buttons to their usual behavior under the selected function, press the function button again.

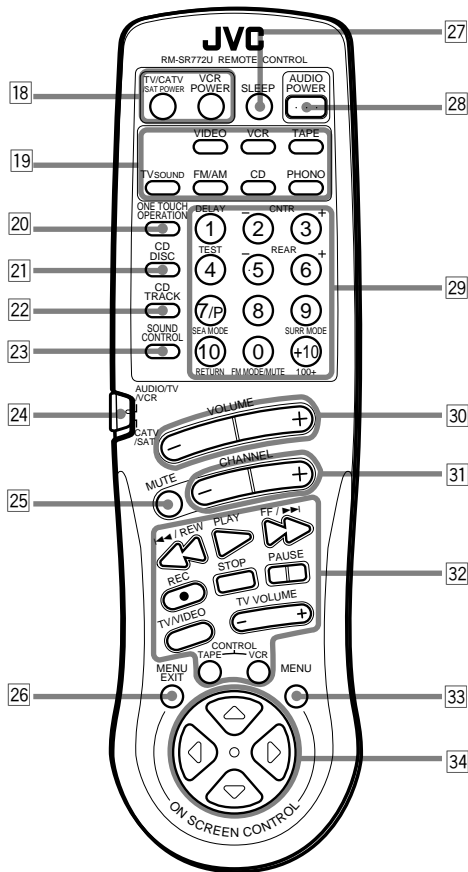

Remote Control Unit

- 18 TV/CATV/SAT POWER and VCR POWER buttons (39)
- 19 Source selecting buttons (12)
- 20 ONE TOUCH OPERATION button (18)
- 21 CD DISC button (38)
- 22 CD TRACK button (38)
- 23 SOUND CONTROL button (22, 25, 29)
- 24 Remote control mode selector (AUDIO/TV/VCR, CATV/SAT) (11)
- 25 MUTE button (13)
- 26 MENU EXIT button (31)
- 27 SLEEP button (15)
- 28 AUDIO POWER button (11)
 - 10 keys for selecting preset channel (20)
 - 10 keys for adjusting sound (22, 25, 29)
 - Operating buttons for audio/video components (38, 40)
- 30 VOLUME buttons (+/-) (12)
- 31 CHANNEL buttons (+/-) (39)
- 32 Operating buttons for audio/video components (38, 40)
- 33 MENU button (31)
- 34 $\Delta / \nabla / \triangleleft / \triangleright$ buttons of the ON SCREEN CONTROL section (31)

IMPORTANT

When using the remote control:

Check to see if its remote control mode selector (24) is set to the correct position.

To operate an audio system, TV, and VCR, set it to the “AUDIO/TV/VCR” position.

To operate a CATV converter and satellite tuner, set it to the “CATV/SAT” position.

About $\Delta / \nabla / \triangleleft / \triangleright$ buttons (34) of the ON SCREEN CONTROL section on the remote control:

If you press these buttons, the menu function starts operating. So, make sure you are showing the on-screen display on the TV before pressing these buttons.

Connecting the FM and AM Antennas

FM Antenna Connections

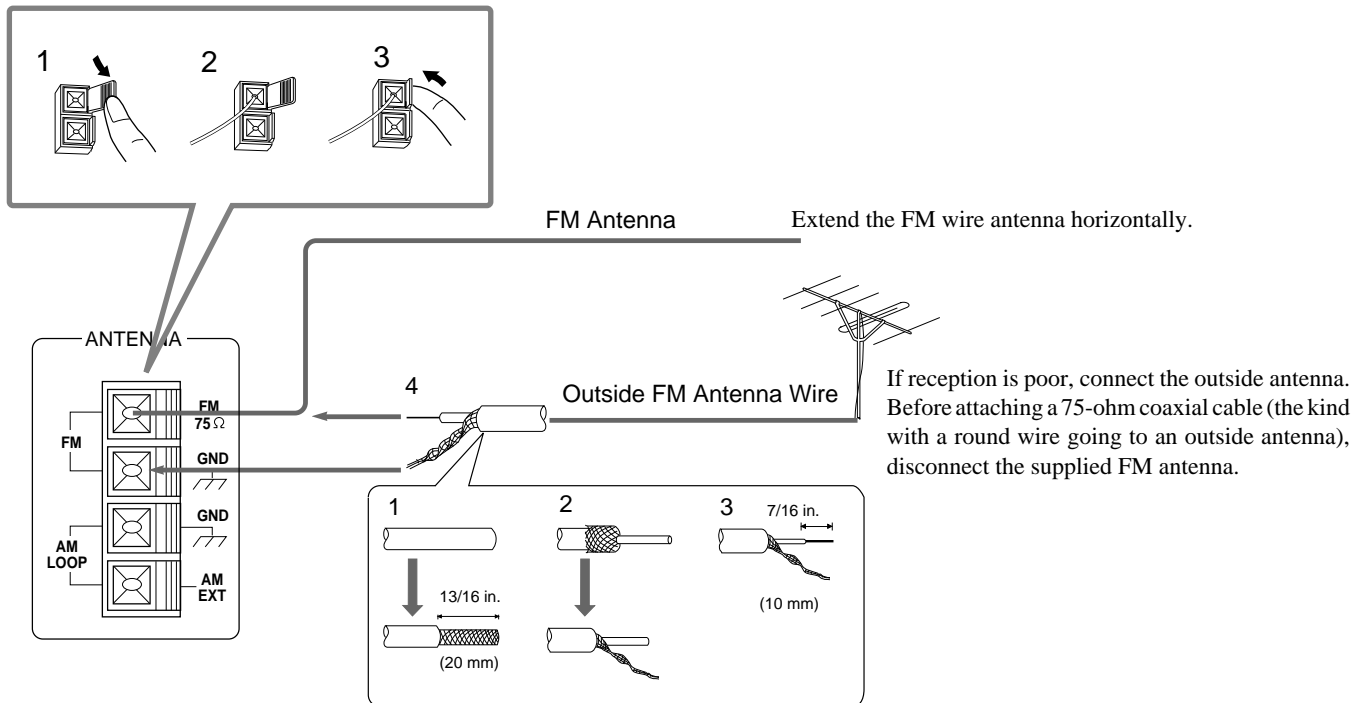

How to strip the 75-ohm coaxial cable and connect it to the FM terminals

1. Strip back the outside covering of the 75-ohm coaxial cable to expose the braided metallic mesh about 13/16 inches (20 mm).
2. Pull the mesh back and twist it into a single connector, as shown in the illustration above.
3. Strip the insulation about 7/16 inches (10 mm) back from the central wire.
4. Insert the twisted mesh and the central wire to the FM terminals, as shown in the illustration above.

AM Antenna Connections

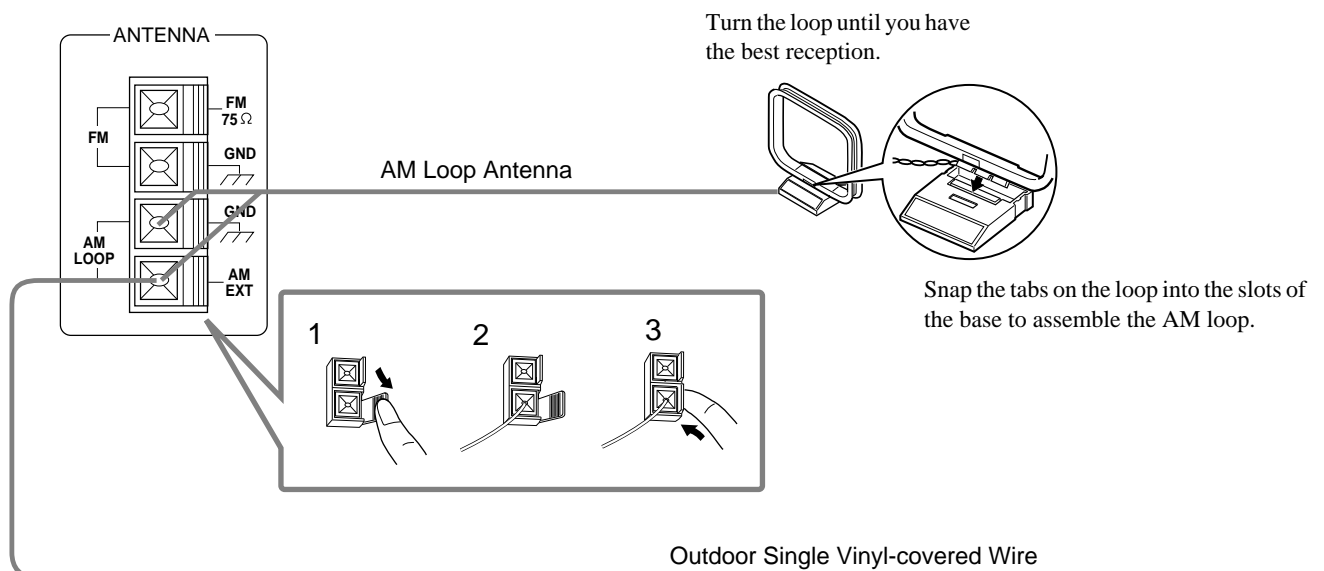

Note:

Make sure the antenna conductors do not touch any other terminals, connecting cords and power cord. This could cause poor reception.

If reception is poor, connect an outdoor single vinyl-covered wire to the AM EXT terminal. (Keep the AM loop antenna connected.)

Connecting the Speakers

You can connect the following speakers:

- Two pairs of front speakers to produce normal stereo sound.
- One pair of rear speakers to enjoy the surround effect.
- One center speaker to produce more effective surround effect (to emphasize human voices).
- One subwoofer to enhance the bass.

For each speaker (except for subwoofer), connect the black (–) and red (+) terminals on the rear panel to the black (–) and red (+) terminals marked on the speakers. For connecting a subwoofer, see page 7.

CAUTION:

Use speakers with the SPEAKER IMPEDANCE indicated by the speaker terminals.

Connecting the front speakers

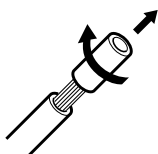

Cut, twist and remove the insulation at the end of each speaker signal cable first, and then, connect the front speakers to the FRONT SPEAKERS terminals by using the cables.

You can connect two pairs of front speakers (one pair to the FRONT SPEAKERS ① terminals, and another pair to the FRONT SPEAKERS ② terminals).

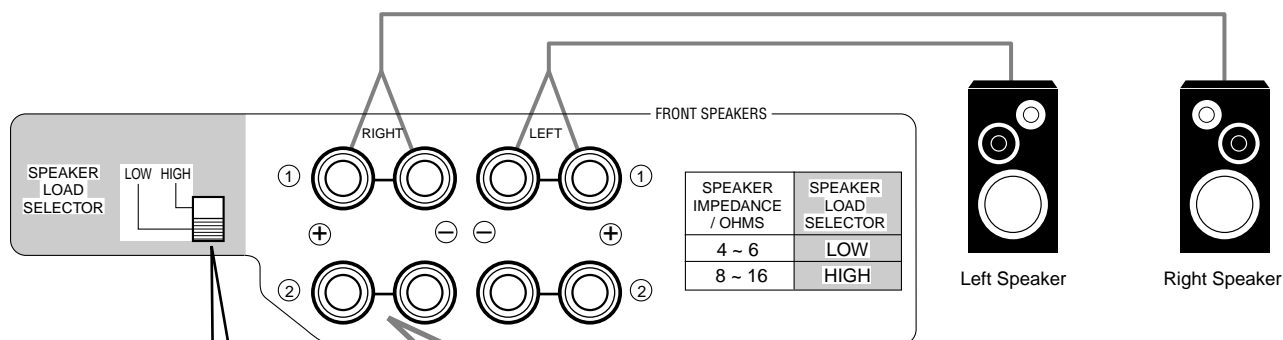

1 Turn the knob counterclockwise.

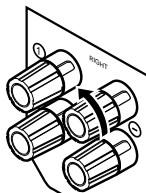

2 Insert the speaker signal cable.

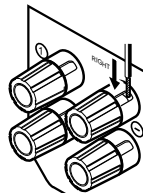

3 Turn the knob clockwise.

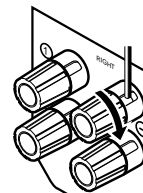

Notes:

- To obtain the best possible output power from the receiver, and to prevent the receiver from being overheated, the receiver has the SPEAKER LOAD SELECTOR which should be set to match the impedance of the connected speakers. Set this selector according to the indications by the FRONT SPEAKERS terminals.
- When you connect two pairs of the speakers to the FRONT SPEAKERS terminals, use the speakers having the impedance within the same range.

Connecting the rear and center speakers

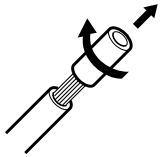

Cut, twist and remove the insulation at the end of each speaker signal cable first, and then, connect rear speakers to the REAR SPEAKERS terminals and a center speaker to the CENTER SPEAKER terminals by using the cables.

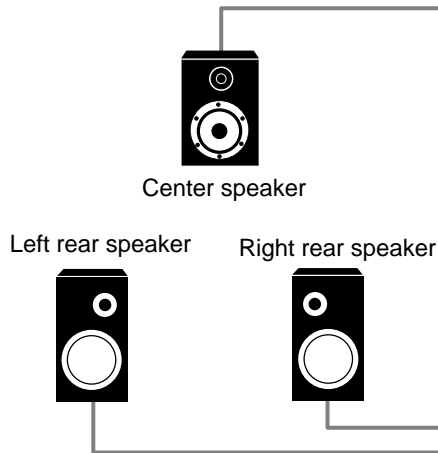

1 Open the terminal and then insert the speaker signal cable.

2 Close the terminal.

Notes:

- You can register the center speaker size after you finish its connection. If you register it, you do not have to set the center speaker mode when setting the surround mode. (If you do not use a center speaker, register that information.) See page 16.
- When you connect rear speakers, make sure that both left and right speakers are connected; otherwise, no sound will come out of the rear speakers.

Connecting the subwoofer speaker

You can enhance the bass by connecting a subwoofer.

Connect the input jack of a powered subwoofer to the SUBWOOFER OUT jack on the rear panel, using a cable with RCA pin plugs.



Connecting Audio/Video Components

You can connect the following audio/video components to this receiver using cables with RCA pin plugs (not supplied). Refer also to the manuals supplied with your components. If you want to connect a component not listed in the table below, refer to the manual supplied with it.

Audio Components	Video Components
• Turntable	• TV
• CD player	• VCR
• Cassette deck	• Video disc player

Note:

- If you connect a sound-enhancing device such as a graphic equalizer between the source components and this receiver, the sound output through this receiver may be distorted.
- Any turntables incorporating a small-output cartridge such as an MC (moving-coil type) must be connected to this receiver through a commercial head amplifier or step-up transformer. Direct connection may result in insufficient volume.

Audio component connections

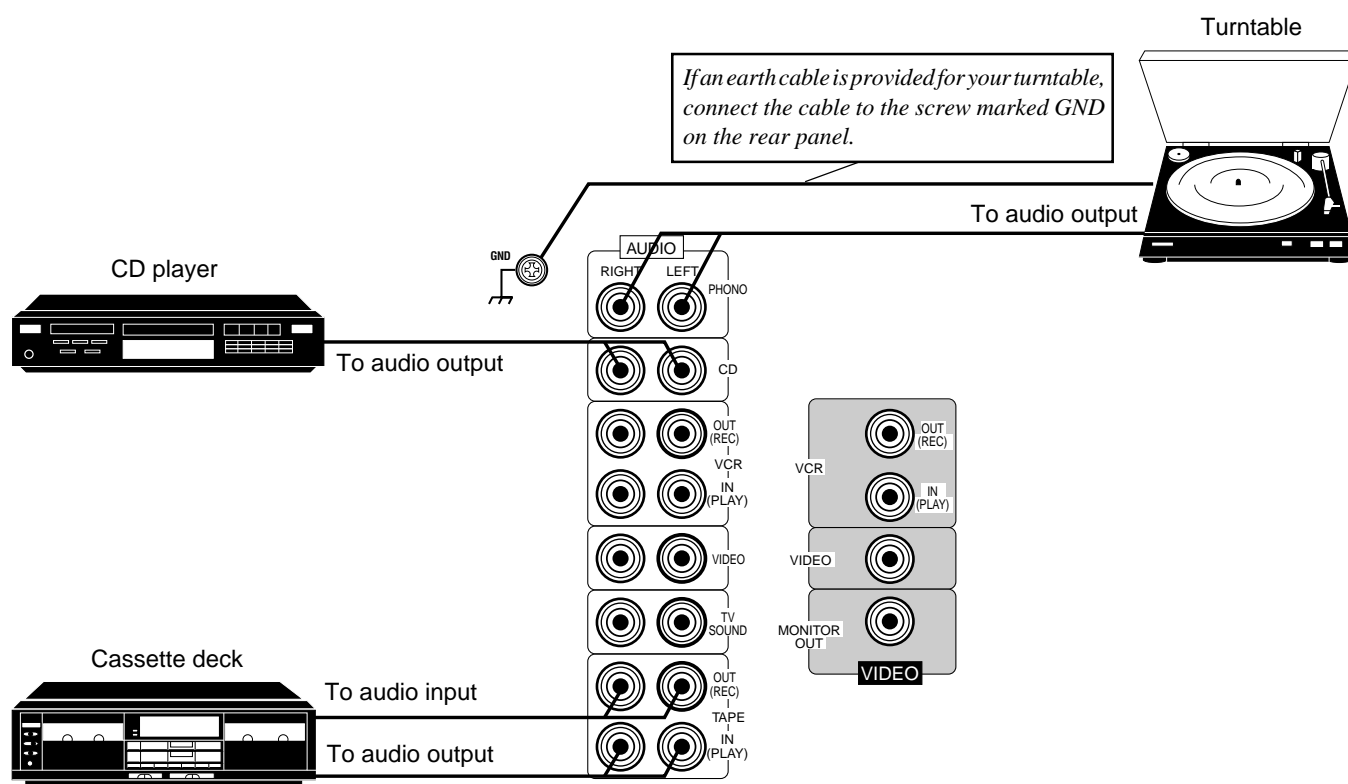

If your audio components have a COMPU LINK-3 terminal

The COMPU LINK remote control system allows you to control other JVC audio components from the receiver or vice versa.

Connect your audio components and the receiver with the cable (monaural mini-plug supplied with those components) as well as the connection above.

For detailed information about the connection and the COMPU LINK-3 remote control system, see page 35.

Note:

The COMPU LINK-3 remote control system is the upgraded version of the COMPU LINK-1 and COMPU LINK-2. Even if your component has the COMPU LINK-1 or COMPU LINK-2 jacks, you can still connect it in the COMPU LINK-3 remote control system, but some functions may not work correctly.

Video component connections

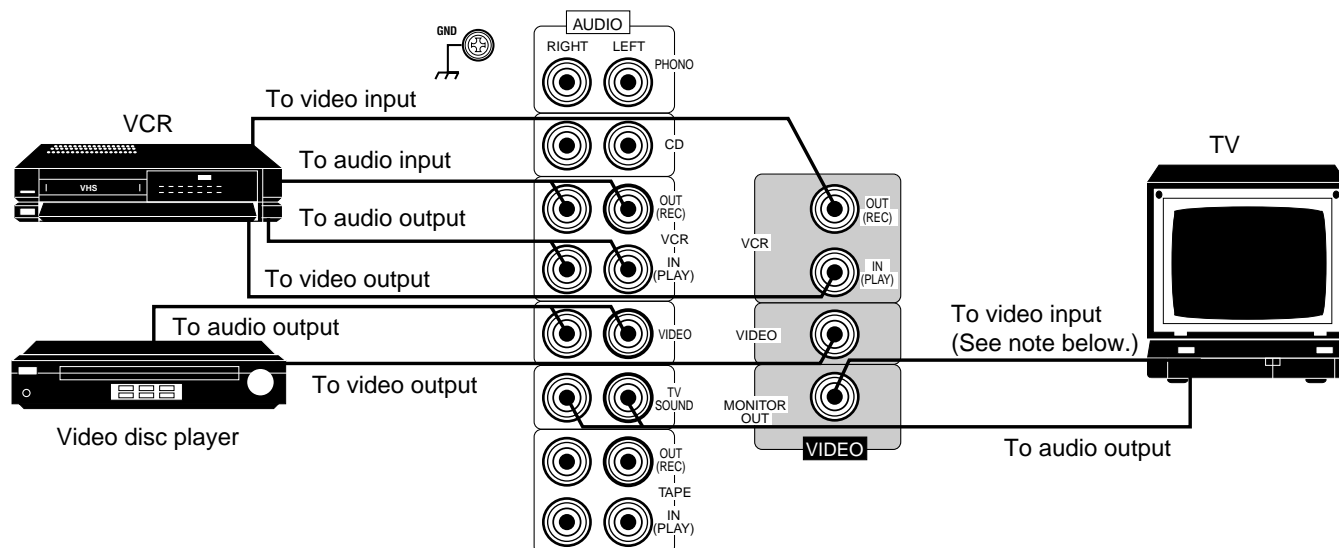

Note:

When connecting a JVC TV:

- If you use the AV COMPU LINK remote control system to operate the TV, connect the receiver to the **Video Input 2 jack** on the TV.
- If you do not use the AV COMPU LINK remote control system to operate TV, connect the receiver to the **Video Input 1 jack** on the TV.

If your video components have an AV COMPU LINK terminal

The AV COMPU LINK remote control system allows you to control other JVC video components from the receiver or vice versa.

For detailed information about the connection and the AV COMPU LINK remote control system, see page 36.

Notes:

- The AV COMPU LINK remote control system cannot control the video components connected to the VIDEO jacks on the receiver, but can control only the VCR connected to the VCR jacks.
- Some VCRs use the AV COMPU LINK jacks for the SWAP editing. However, you cannot use both the AV COMPU LINK remote control and the SWAP editing at the same time. For the SWAP editing, see the manual supplied with the VCR.

Connecting the Power Cord

Before plugging the receiver into an AC outlet, make sure that all connections have been made. When the power cord is connected, the STANDBY lamp above the POWER button lights up.

Keep the power cord away from the connecting cables for the TV, VCR, and antenna. The power cord may cause noise or screen interference. We recommend that you use a coaxial cable to connect the antenna, since it is well-shielded against interference.

Notes:

- A small amount of power is always consumed even in standby mode. To switch off the power completely, unplug the power cord from the AC outlet.
- If the power cord is unplugged or a power failure occurs, preset settings will be erased in a few days.

CAUTIONS:

- Do not touch the power cord with wet hands.
- Do not pull on the power cord to unplug the cord. When unplugging the cord, always grasp the plug so as not to damage the cord.

Putting Batteries in the Remote Control

Before using the remote control, put two supplied batteries first. When using the remote control, aim the remote control directly at the remote sensor on the receiver.

1. On the back of the remote control, remove the cover as illustrated.
2. Insert batteries. Make sure to observe the proper polarity: (+) to (+) and (-) to (-).
3. Replace the cover in.

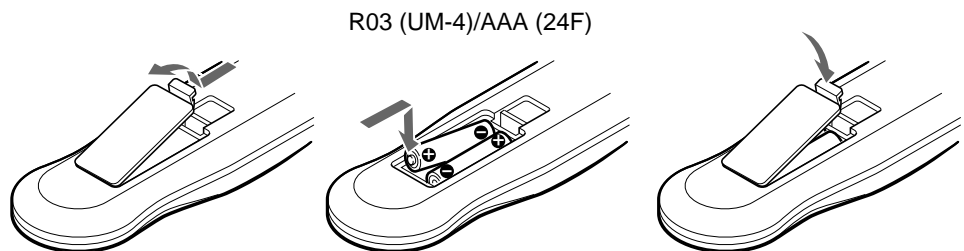

If the range or effectiveness of the remote control decreases, replace the batteries. Use two R03 (UM-4)/AAA (24F) type dry-cell batteries.

CAUTIONS:

Follow these precautions to avoid leaking or cracking cells:

- Place batteries in the remote control so they match the polarity indicated: (+) to (+) and (-) to (-).
- Use the correct type of batteries. Batteries that look similar may differ in voltage.
- Always replace both batteries at the same time.
- Do not expose batteries to heat or flame.

Basic Operations

The following operations are commonly used when you play any sound source.

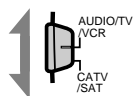

IMPORTANT

When using the Remote Control, check to see if its remote control mode selector is set to the correct position:

- To operate an audio system, TV, and VCR, set it to the "AUDIO/TV/VCR" position.
- To operate a CATV converter and satellite tuner, set it to the "CATV/SAT" position.

Turning the Power On and Off

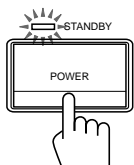
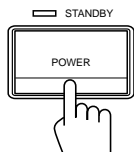

Front panel

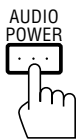

Remote Control

On the front panel:

To turn on the power, press POWER.

The STANDBY lamp goes off. The name of the current source (or station frequency) appears on the display.

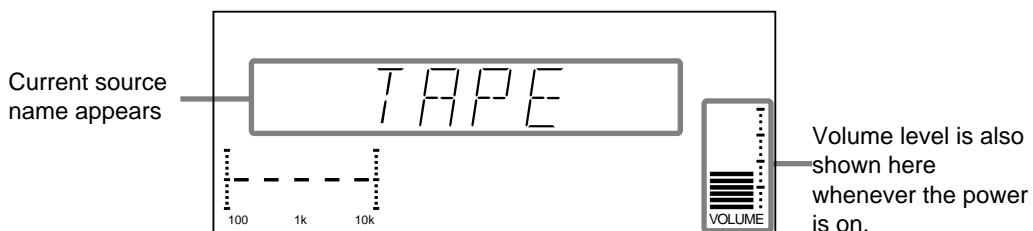

To turn off the power, press POWER again.

The STANDBY lamp lights up.

From the remote control:

To turn on the power, press AUDIO POWER.

The STANDBY lamp goes off. The name of the current source appears on the display.

To turn off the power, press AUDIO POWER again.

The STANDBY lamp lights up.



See also page 31.

Selecting the Source to Play

You need to select the source before you start playing any source.

On the front panel:

1. Press SOURCE so that the Control Δ / ∇ buttons work for selecting the source. The selected source lamp also lights up.
2. Press Control Δ / ∇ until the source name you want appears on the display.

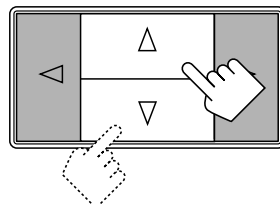
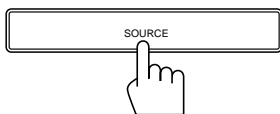

Front panel

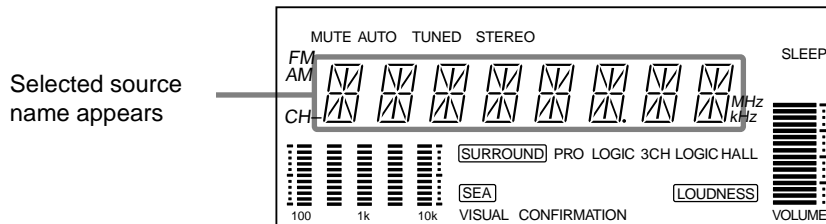

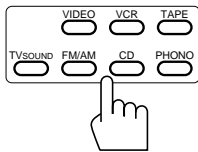

Remote Control

From the remote control:

Press one of the source selecting buttons you want.

- VIDEO Play back a video source on the video component connected to the VIDEO jacks.
- VCR Play back a video source on the video component connected to the VCR jacks.
- TV SOUND Listen to TV sounds.
- FM/AM* Listen to the radio.
Each time you press the button, the band alternates between FM and AM.
- TAPE* Listen to a cassette tape connected to the TAPE jacks.
- CD* Listen to a CD.
- PHONO* Listen to a record.

Note:

When you press one of the source selecting buttons marked above with an asterisk (*), the receiver automatically turns on.

Adjusting the Volume

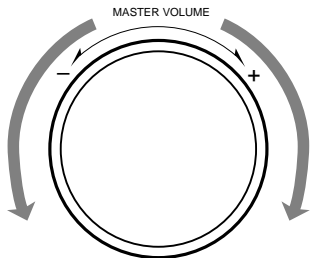

Front panel

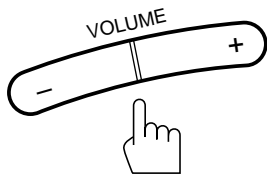

Remote Control

When you change the volume level, the volume level is shown on the display.

On the front panel:

To increase the volume, turn MASTER VOLUME clockwise.

To decrease the volume, turn MASTER VOLUME counterclockwise.

Note:

When you turn MASTER VOLUME **rapidly**, the volume level also changes **rapidly**.
When you turn MASTER VOLUME **slowly**, the volume level also changes **slowly**.

From the remote control:

To increase the volume, press VOLUME +.

To decrease the volume, press VOLUME -.

CAUTION:

Always set the volume level to the minimum before starting any source. If the volume level is left turned up, the sudden blast of sound energy can permanently damage your hearing and/or ruin your speakers.

Selecting the Front Speakers

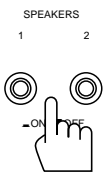

Front panel

On the front panel only:

When you have connected two pairs of the front speakers, you can select which to use. Pressing SPEAKERS 1 or SPEAKERS 2 to set it in the **ON** position activates the respective pair of the speakers.

To use the speakers connected to the FRONT SPEAKERS ① terminals, press SPEAKERS 1 to set it in the **ON** position, and press SPEAKERS 2 to set it in the **OFF** position.

To use the speakers connected to the FRONT SPEAKERS ② terminals, press SPEAKERS 2 to set it in the **ON** position, and press SPEAKERS 1 to set it in the **OFF** position.

To use both pairs of the speakers, press both SPEAKERS 1 and 2 to set them in the **ON** position.

To use neither pair of the speakers, press both SPEAKERS 1 and 2 to set them in the **OFF** position.

Note:

When only one set of the speakers is connected to either the FRONT SPEAKERS ① or ② terminals, do not press both SPEAKERS 1 and 2 to set them in the **ON** position. If you do, no sound comes out of the front speakers.

Listening with Headphones

A standard pair of headphones can be connected to the PHONES jack on the front panel.

To listen with only headphones, press both SPEAKERS 1 and 2 to set them in the **■OFF** position. No sound comes out of the front speakers.

CAUTION:

Be sure to turn down the volume before connecting or putting on headphones, as high volume can damage both the headphones and your hearing.

Muting the Sound



Remote Control

From the remote control only:

To mute the sound through all the speakers and headphones connected, press MUTE so that "MUTE" appears on the display and the volume turns off.

To cancel the mute, press MUTE again so that "OFF" appears on the display. Turning MASTER VOLUME or pressing VOLUME +/- also restores the sound at the previous volume level.

Recording a Source

You can record any source playing through the receiver to the cassette deck connected to the TAPE jacks and the VCR connected to the VCR jacks at the same time.

While recording, you can listen to the selected sound source at whatever sound level you like, without affecting the sound levels of the recording.

Note:

The output volume level, SEA and surround adjustments cannot affect the recording.

Basic Settings

Some of the following settings are required after connecting and positioning your speakers in your listening room, while others will make operations easier.

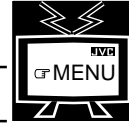

See also page 31.

Adjusting the Front Speaker Output Balance

If the sounds you hear from the front right and left speakers are unequal, you can adjust the speaker output balance.

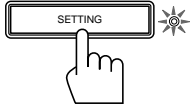

On the front panel only:

1. Press **SETTING** so that the Control Δ / ∇ / \triangleleft / \triangleright buttons work for adjusting the balance.
The lamp next to the button lights up.

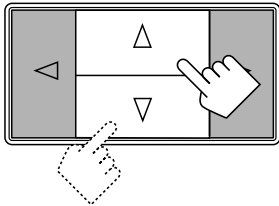

2. Press Control Δ / ∇ until “BALANCE” appears on the display.

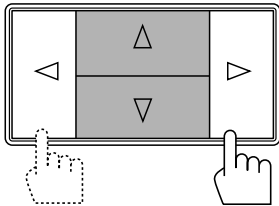

3. Press Control \triangleleft / \triangleright to adjust the balance.
 - Pressing Control \triangleleft decreases the right channel output.
 - Pressing Control \triangleright decreases the left channel output.

Front panel



See also page 32.

Listening at Low Volume (Loudness)

Human ears are not sensitive to bass at low volume. To compensate for this, the loudness function automatically boosts the bass level as you lower the volume.

Note:

The loudness function affects the front speaker sounds only.

On the front panel only:

1. Press **SETTING** so that the Control Δ / ∇ / \triangleleft / \triangleright buttons work for setting the loudness function.
The lamp next to the button lights up.

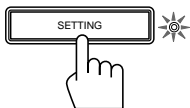

2. Press Control Δ / ∇ until “LOUDNESS” appears on the display.

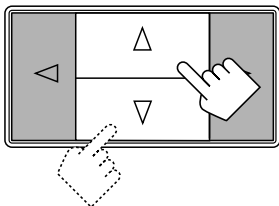

3. Press Control \triangleleft / \triangleright to set the loudness function to “ON” or “OFF.”

- Select “ON” to activate the loudness function.
The LOUDNESS indicator lights up on the display.
- Select “OFF” to cancel it.
The indicator goes off.

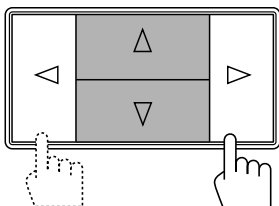

Front panel



Using the Sleep Timer

Using the Sleep Timer, you can fall asleep to music and know the receiver will turn off by itself rather than play all night.

On the front panel:

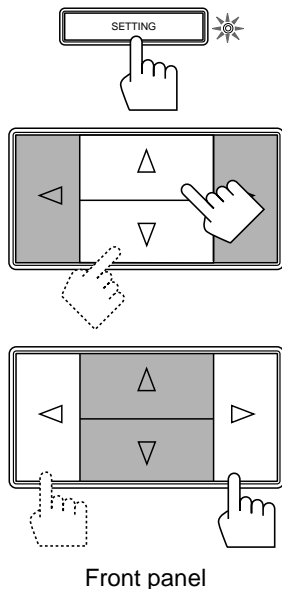

1. Press **SETTING** so that the **Control Δ / ▽ / ◀ / ▶** buttons work for setting the Sleep Timer.
The lamp next to the button lights up.
2. Press **Control Δ / ▽** until “<SLEEP>” appears on the display.
3. Press **Control ◀ / ▶** to set the shut-off time.

Each time you press the button, the shut-off time on the display changes as follows:
The SLEEP indicator lights up on the display.

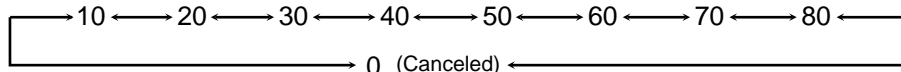

When the shut-off time comes

The receiver turns off automatically.

To check or change the time remaining until the shut-off time

1. Press **SETTING**, if necessary, so that the **Control Δ / ▽ / ◀ / ▶** buttons work for setting the Sleep Timer.
2. Press **Control Δ / ▽**, if necessary, until “<SLEEP>” appears on the display.
3. Press **Control ◀ / ▶** once.
The remaining time until the shut-off time appears in minutes.
 - To change the shut-off time, press **Control ◀ / ▶** repeatedly.

To cancel the Sleep Timer

Press **Control ◀ / ▶** repeatedly in step 3 above until “0” appears on the display. (The SLEEP indicator goes off.) Turning off the power also cancels the Sleep Timer.

From the remote control:

Press SLEEP repeatedly.

The SLEEP indicator lights up and the shut-off time appears on the display.

Each time you press the button, the shut-off time on the display changes as follows:

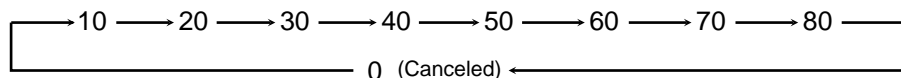

To check or change the time remaining until the shut-off time

Press **SLEEP** once. The remaining time until the shut-off time appears in minutes.

- To change the shut-off time, press **SLEEP** repeatedly.

To cancel the Sleep Timer

Press **SLEEP** repeatedly until “0” appears on the display. (The SLEEP indicator goes off.)

Turning off the power also cancels the Sleep Timer.



Remote Control



Selecting the Center Speaker Size

You can register the information on the center speaker after all connections are completed. If you do this registration first, you do not have to adjust the center speaker mode when you want to activate the Dolby surround. However, to register the information, first you have to set the surround mode either to "PROLOGIC" or "3CHLOGIC." (You cannot select the center speaker size when the surround mode is "SURR OFF" or "HALL.")

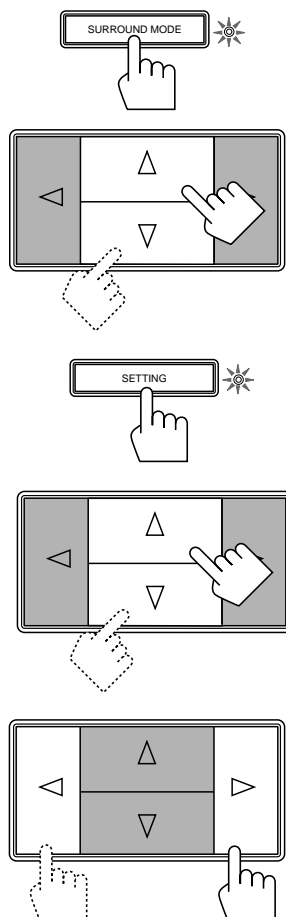

Front panel

On the front panel only:

1. Press **SURROUND MODE** so that the Control Δ / ∇ buttons work for selecting the surround mode.
The lamp next to the button lights up.
2. Press Control Δ / ∇ until "**PROLOGIC**" or "**3CHLOGIC**" whichever you want appears on the display.
The PRO LOGIC or 3CH LOGIC indicator (as well as the SURROUND indicator) also lights up.
3. Press **SETTING** so that the Control $\Delta / \nabla / \triangleleft / \triangleright$ buttons work for selecting the center speaker size.
The lamp next to the button lights up.
4. Press Control Δ / ∇ until "**CNTR SPK**" (Center Speaker) appears on the display.
5. Press Control $\triangleleft / \triangleright$ to select the appropriate item about your center speaker.
Each time you press the button, the display changes to show the following:

→ LARGE ← SMALL ← NO ←

LARGE:	Select this mode when the size of the center speaker is the same as that of the front speakers.
SMALL:	Select this mode when the size of the center speaker is smaller than that of the front speakers.
NO:	Select this mode when you do not use a center speaker. (You cannot select this mode when "3CHLOGIC" is selected for the surround mode.)

Note:

This center speaker size setting is so related to the center mode setting for the surround mode that changing this setting affects and changes the center mode to a relevant mode, and vice versa.

For example;

- If you select "**LARGE**," the center mode is automatically set to "**WIDE**," and vice versa.
- If you select "**SMALL**," the center mode is automatically set to "**NORMAL**," and vice versa.
- If you select "**NO**," the center mode is automatically set to "**PHANTOM**" for Pro Logic, and vice versa.



Using Visual Confirmation

When you operate the receiver, you can see what you are doing, by showing it on the TV screen. To use this function, you need to connect the TV to the MONITOR OUT jack on the rear panel (see page 9), and set the TV's input mode to the proper position to which the receiver is connected. When the TV's input mode is for TV, you cannot see the on-screen display.

On the front panel only:

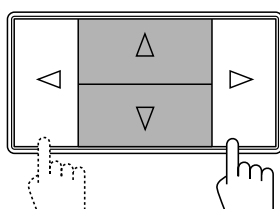
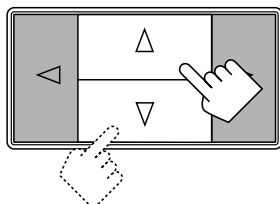
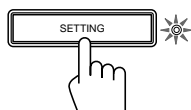

Front panel

1. Press **SETTING** so that the Control $\Delta / \nabla / \triangleleft / \triangleright$ buttons work for setting Visual Confirmation.

The lamp next to the button lights up.

2. Press Control Δ / ∇ until "VCONFIRM" appears on the display.

3. Press Control $\triangleleft / \triangleright$ to set Visual Confirmation to "ON" or "OFF."

- Select "ON" to activate Visual Confirmation.
The VISUAL CONFIRMATION indicator lights up on the display.
- Select "OFF" to cancel it.
The indicator goes off.

EXAMPLES:

When changing the source:

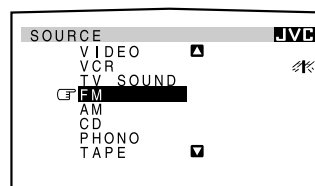

The SOURCE menu appears on the TV screen for about 5 seconds.

When adjusting the front speaker output balance:

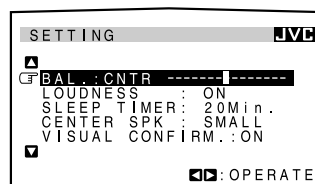

The SETTING menu appears on the TV screen for about 5 seconds.

When selecting your favorite SEA mode:

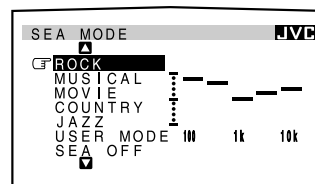

The SEA MODE menu appears on the TV screen for about 5 seconds.

One Touch Operation

This receiver can memorize the optimum sound settings for each playing source.

About the One Touch Operation

JVC's One Touch Operation function is used to assign and store different sound settings for each different playing source. By using this function, you don't have to change the settings every time you change the source. The stored settings for the newly selected source are automatically recalled.

The following can be stored for each source:

- Volume level (see page 12)
- Balance (see page 14)
- Loudness (see page 14)
- SEA modes (see page 22)
- Surround mode settings (see page 24)

Note:

If the source is FM or AM, the One Touch Operation function works only when the preset channels from 1 — 20 are tuned in. You can assign a different setting for each preset channel.

Using the One Touch Operation



Front panel



Remote control

To store the sound settings

1. Press ONE TOUCH OPERATION.

The ONE TOUCH OPERATION lamp lights up, then the previously memorized settings are recalled and appear on the display in turn.

2. Adjust the sound using the functions listed above.

The newly adjusted settings are memorized.

To recall the sound settings

With the ONE TOUCH OPERATION lamp lit, the settings for the currently selected source is recalled, and appears on the display when the source is selected.

To cancel the One Touch Operation function

Press ONE TOUCH OPERATION so that the lamp goes off.

(Even though the One Touch Operation function is canceled, the recalled sound effects remain active.)

Receiving Radio Broadcasts

You can browse through all the stations or use the preset function to go immediately to a particular station.



See also page 33.

Tuning in Stations Manually

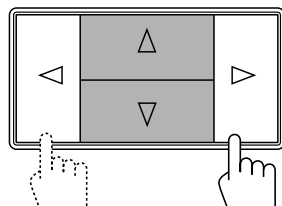
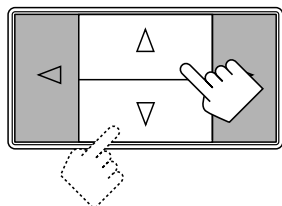
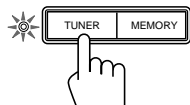

Front panel

On the front panel only:

1. Press **TUNER** so that the Control Δ / ∇ / \triangleleft / \triangleright buttons work for tuner settings. The lamp next to the button lights up.
2. Press Control Δ / ∇ until “<FM AM>” appears on the display.
3. Press Control \triangleleft / \triangleright to select the band. Each time you press the button, the band alternates between FM and AM.
4. Press Control Δ / ∇ until “-TUNING+” appears on the display.
5. Press Control \triangleleft / \triangleright until you find the frequency you want.
 - Pressing Control \triangleleft decreases the frequency.
 - Pressing Control \triangleright increases the frequency.

Notes:

- When you hold down Control \triangleleft / \triangleright in step 5, the frequency keeps changing until you press the button again or a station is tuned in.
- When a station of sufficient signal strength is tuned in, the TUNED indicator lights up on the display. When an FM stereo program is received, the STEREO indicator also lights up.



See also page 33.

Using Preset Tuning

Once a station is assigned to a channel number, the station can be quickly tuned. You can preset up to 40 stations at random.

To store the preset stations

On the front panel only:

1. **Tune in the station you want to preset (see above).**
If you want to store the FM reception mode for this station, select the FM reception mode you want. See page 20 for details.
2. Press **MEMORY** (next to the TUNER button).
“CH-” appears and the channel number position starts flashing on the display for about 5 seconds.
3. Press Control Δ / ∇ to select a channel number while the channel number position is flashing.
 - Pressing Control Δ increases the number.
 - Pressing Control ∇ decreases the number.
4. Press **MEMORY** (next the TUNER button) again while the selected channel number is flashing on the display.
The selected channel number stops flashing.
The station is assigned to the selected channel number.
5. Repeat steps 1 to 4 until you store all the stations you want.

To cancel a stored preset station

Storing a new station on a used number erases the previously stored one.

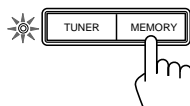
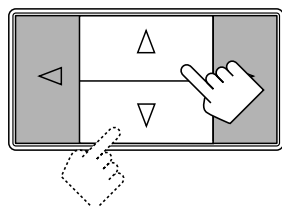
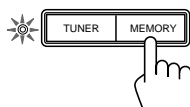

Front panel

CAUTION:

Preset stations may be erased when power is cut off to the receiver, as when it is unplugged from the AC outlet or a power failure occurs. If the preset stations are lost, simply set the stations again.

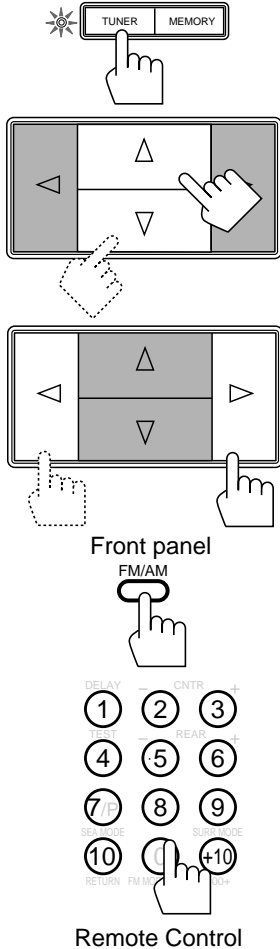
To tune in a preset station**On the front panel:**

1. Press TUNER so that the Control Δ / ▽ / ◀ / ▶ buttons work for tuner settings. The lamp next to the button lights up.
2. Press Control Δ / ▽ until “-PRESET+” appears on the display.
3. Press Control ◀ / ▶ to select a preset channel. Each time you press the button, the preset channels changes.
 - Pressing Control ◀ changes preset channels in decreasing order.
 - Pressing Control ▶ changes preset channels in increasing order.

From the remote control:

1. Press FM/AM. Each time you press the button, the band alternates between FM and AM.
2. Press 10 keys to select a preset channel number.
 - For channel number 5, press 5.
 - For channel number 15, press +10 then 5.
 - For channel number 20, press +10 then 10.
 - For channel number 30, press +10, +10, then 10.

Note:

When you use the 10 keys on the remote control, be sure that they are activated for tuner, not for the CD and others. (See page 38.)

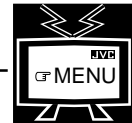

See also page 33.

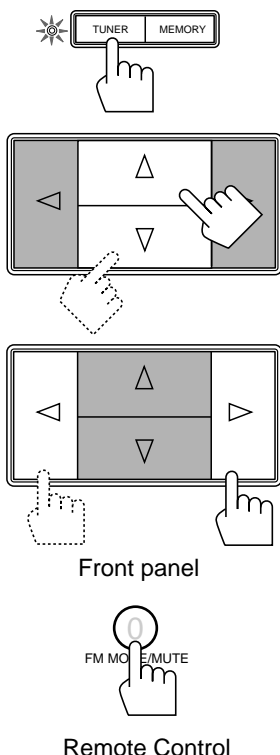
Selecting the FM Reception Mode

You can change the FM reception mode while listening an FM broadcast. You can also store the FM reception mode for each preset station. (See page 19.)

On the front panel:

1. Press TUNER so that the Control Δ / ▽ / ◀ / ▶ buttons work for tuner settings. The lamp next to the button lights up.
2. Press Control Δ / ▽ until “FM MODE” appears on the display.
3. Press Control ◀ / ▶ to select either “AUTO” or “MONO.”
 - Normally select “AUTO.”
 - When an FM stereo broadcast is hard to receive or noisy, select “MONO.”

AUTO:	When a program is broadcast in stereo, you will hear stereo sound; when in monaural, you will hear monaural sounds. This mode is also useful to suppress static noise between stations. The MUTE AUTO indicator lights up on the display.
MONO:	Reception will be improved although you will lose the stereo effect. In this mode, you will hear noise while tuning into the stations. The MUTE AUTO indicator goes off on the display.

From the remote control:**Press FM MODE/MUTE.**

Each time you press the button, “AUTO” and “MONO” is alternately selected, and appears on the display.

Note:

When using the FM MODE/MUTE button, be sure that the 10 keys are activated for tuner, not for the CD and others. (See page 38.)



Assigning Names to Preset Stations

You can assign a name of up to five characters to each preset station (from preset channel number 1 to 20). When a preset station is tuned in, its assigned name will appear on the display.

On the front panel only:

1. **Tune in a preset station (preset channel number 1 to 20).**

See page 20 for details.

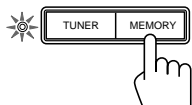

2. **Press MEMORY (next to the TUNER button).**

The preset channel number starts flashing.

Note:

If you press Control Δ / ∇ while the preset channel number is flashing, you can change the preset channel number.

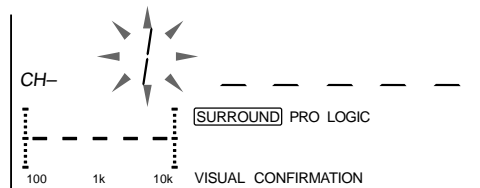

3. **Press Control \triangleright (or \triangleleft) until the first character position starts flashing.**

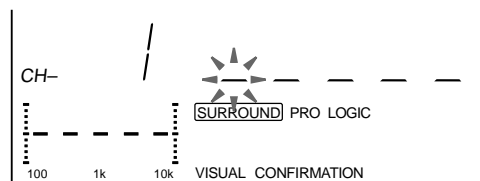
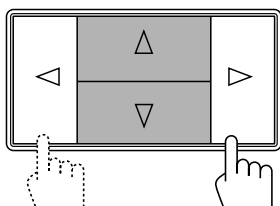

4. **Press Control Δ / ∇ to select a character.**

You can use the characters listed below.

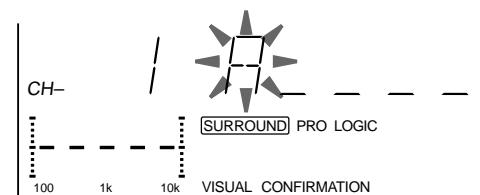
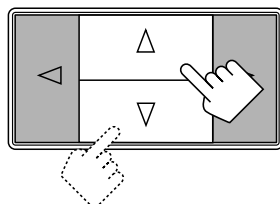

5. **When a character you want appears, press Control \triangleright (or \triangleleft).**

The next (or previous) character position starts flashing.

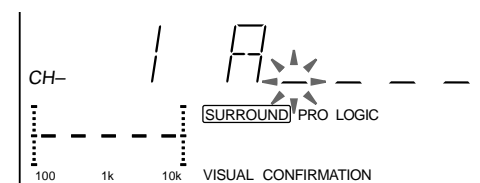
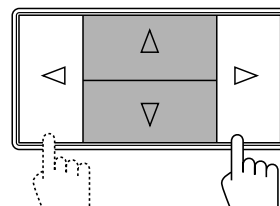

6. **Repeat steps 4 and 5 to enter up to five characters.**

7. **Press MEMORY (next to the TUNER button) again, while the last selected character is flashing, after you have assigned a name.**

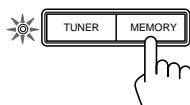

Front panel

To erase the input characters

Insert blanks using the same procedure described above.

Available characters

Blank	A	B	C	D	E	F	G	H	I	J	K	L	M	N	O	
	P	Q	R	S	T	U	V	W	X	Y	Z	0	1	2	3	4
	5	6	7	8	9											

Using the SEA Modes

The SEA (Sound Effect Amplifier) modes give you control of the way your music sounds.

Note:

The SEA modes cannot be used for recording.



See also page 33.

Selecting Your Favorite SEA Mode

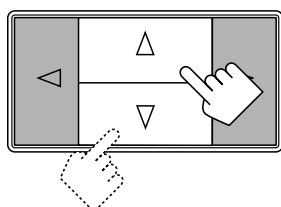
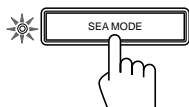

Front panel

On the front panel:

1. Press SEA MODE so that the Control Δ / ∇ buttons work for selecting the SEA mode. The lamp next to the button lights up.
2. Press Control Δ / ∇ until the mode you want appears on the display. Each time you press the button, the SEA mode changes as follows:

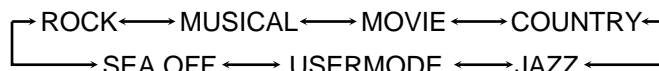

Note:

When the SEA mode is turned on, the SEA indicator lights up on the display.

ROCK:	Gives a heavy sound. Both high and low frequencies are boosted.
MUSICAL:	Enhance the mid-frequency range, which the human voice is mostly made up of.
MOVIE:	Adds breadth to sounds so you feel like you are in a movie theater.
COUNTRY:	Enhances the high-frequency range so that instruments such the violin and banjo are emphasized.
JAZZ:	Gives a feeling of a live atmosphere. Good for acoustic music.
USERMODE:	Your original SEA adjustment (see page 23).
SEA OFF:	No SEA mode is applied (see below).

To cancel the SEA mode, press Control Δ / ∇ until “SEA OFF” appears in step 2 above. The SEA indicator goes off from the display.

From the remote control:

1. Press the SOUND CONTROL. Pressing this button activates the 10 keys for adjusting the sounds.
2. Press the SEA MODE button repeatedly until the SEA mode you want appears on the display. Each time you press the button, the SEA mode changes as follows:

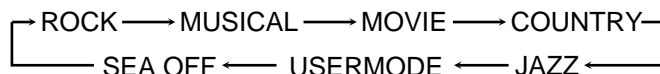

Note:

When the SEA mode is turned on, the SEA indicator lights up on the display.

To cancel the SEA mode, press SEA MODE until “SEA OFF” appears in step 2 above. The SEA indicator goes off from the display.

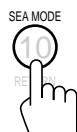

Remote Control



Creating Your Own SEA Mode

You can adjust and store your own SEA adjustment into memory (USERMODE).

On the front panel *only*:

If you do not want to store your adjustment, but rather want to adjust the SEA temporarily, skip step 3 below.

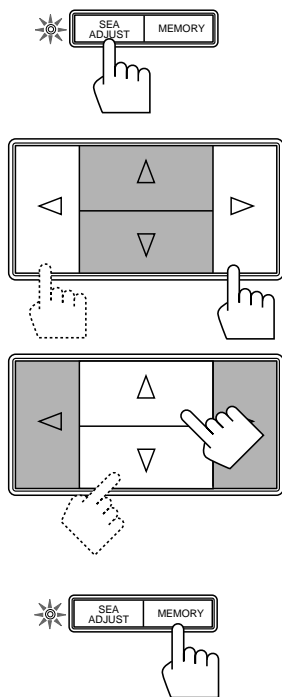

Front panel

1. Press SEA ADJUST so that the Control Δ / ∇ / \triangleleft / \triangleright buttons work for the SEA adjustment.

The lamp next to the button lights up.

2. Adjust the SEA frequency and its level.

- Press Control \triangleleft / \triangleright to select the frequency range to adjust.
- Press Control Δ / ∇ to adjust the level.

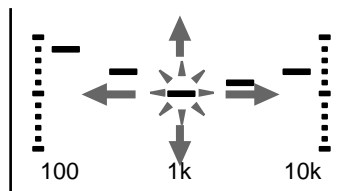

3. Press MEMORY (next to the SEA ADJUST button).

Your adjustment is stored into USERMODE.

To recall your own SEA adjustment

See page 22.

To erase a stored adjustment

Storing a new adjustment into USERMODE erases the previously stored one.

Using the Surround Processor

The built-in surround processor provides three types of surround programs — Dolby Pro Logic, Dolby 3-Channel Logic, and JVC's Hall Surround.

What is surround?

The sound heard in a concert hall or a movie theater consists of direct sound and indirect sound: early reflections and reflections from behind. The reflected sounds are always delayed by the distances of the ceiling and walls from the listener. These reflections are some of the most important elements of the acoustic surround.

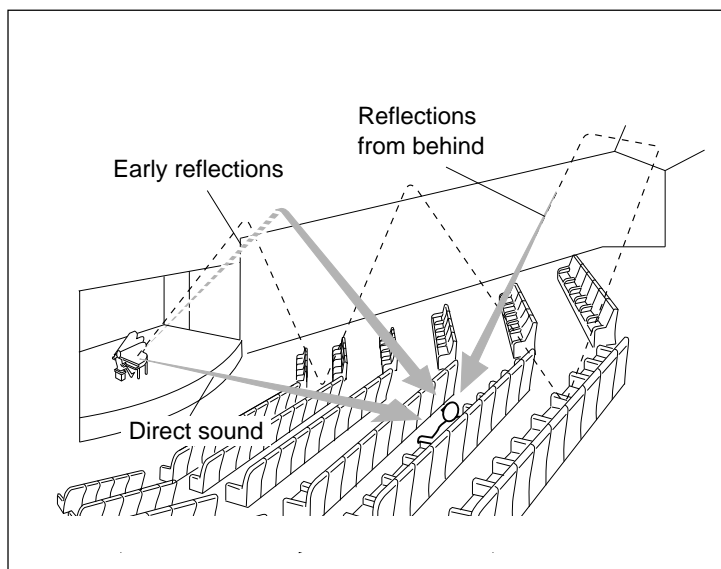

On JVC's Hall Surround

In order to reproduce a more realistic sound field in your listening room while playing an ordinary stereo source, JVC's Hall Surround has been designed to give you clear vocals and to create the feeling of a concert hall. The sound is reproduced through the front speakers and rear speakers.

On Dolby Surround

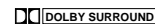
Dolby Surround has been also developed to reproduce the important elements of the acoustic surround at home. To watch the soundtracks of video software bearing the mark  * which includes the same encoded surround information as found in Dolby Stereo films, the receiver can provide you with 2 Dolby Surround programs (Dolby Pro Logic and Dolby 3ch Logic).

Dolby Pro Logic: Select this mode when the optional rear speakers are connected (as well as a center speaker).

Dolby 3ch Logic: Select this mode when a center speaker is connected without rear speakers.

* Manufactured under license from Dolby Laboratories Licensing Corporation. Additionally licensed under Canadian patent number 1,037,877. "Dolby," the double-D symbol, and "ProLogic" are trademarks of Dolby Laboratories Licensing Corporation.

Notes:

- The surround processor has no effect on monaural sources.
- The surround processor cannot be used for recording.



See also page 34.

Using JVC's Hall Surround

You need to connect one set of rear speakers to obtain the full effect. Once you have adjusted the Hall Surround, the receiver memorizes the settings.

On the front panel:

1. Press SURROUND MODE so that the Control Δ / ∇ buttons work for selecting the surround modes.

The lamp next to the button lights up.

2. Press Control Δ / ∇ until "HALL" appears on the display.

The HALL and SURROUND indicators also light up on the display.

Each time you press the button, the surround modes change as follows (the indicator of the selected surround mode also lights up on the display):

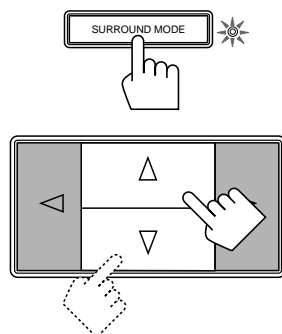
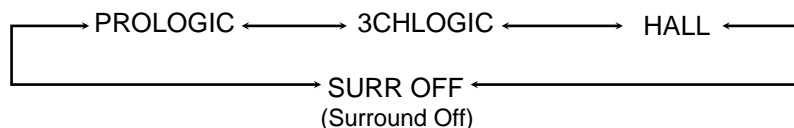

Front panel

To be continued to the next page



3. Press SURROUND ADJUST so that the Control Δ / ∇ / \triangleleft / \triangleright buttons work for the surround settings.

The lamp next to the button lights up.

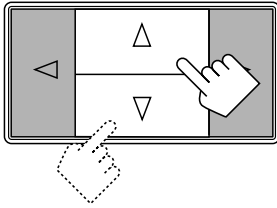

4. Press Control Δ / ∇ until “- REAR +” appears on the display.

5. Press Control \triangleleft / \triangleright to adjust the rear speaker output level.

- Pressing Control \triangleleft decreases the output level up to -10 dB.
- Pressing Control \triangleright increases the output level up to +10 dB.

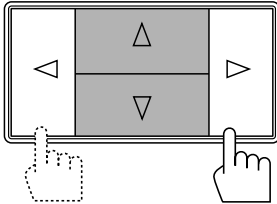

6. Press Control Δ / ∇ until “-DELAY +” appears on the display.

7. Press Control \triangleleft / \triangleright to adjust the delay time of the rear speaker output.

Each time you press the button, the delay time changes as follows:

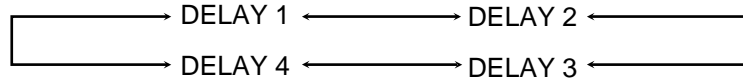

Front panel

DELAY 1:	Select this when the distance from you to your rear speakers is greater than that to the front speakers.
DELAY 2:	Select this when the distance from you to your rear speakers is almost equal to that to the front speakers.
DELAY 3:	Select this when the distance from you to your rear speakers is a little less than that to the front speakers.
DELAY 4:	Select this when the distance from you to your rear speakers is much less than that to the front speakers.

To cancel the Hall surround, press Control Δ / ∇ until “SURR OFF” appears in step 2. The HALL and SURROUND indicators go off.

From the remote control:

1. Press SOUND CONTROL.

The remote control is activated for adjusting the sound.



2. Press SURR MODE until “HALL” appears on the display.

The HALL and SURROUND indicators also light up on the display.

Each time you press the button, the surround modes change as follows (the indicator of the selected surround mode also lights up on the display):

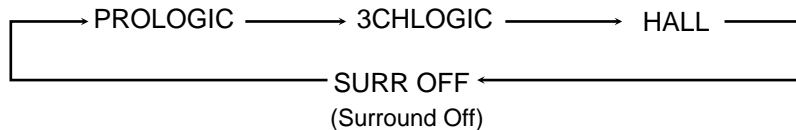

3. Press REAR +/- to adjust the rear speaker output level.

- Pressing REAR - decreases the output level up to -10 dB.
- Pressing REAR + increases the output level up to +10 dB.



4. Press DELAY to adjust the delay time of the rear speaker output.

Each time you press the button, the delay time changes as follows:

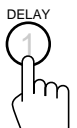
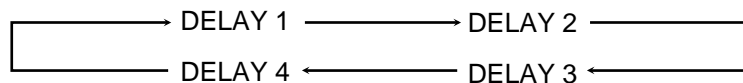

Remote Control

To cancel the Hall Surround, press SURR MODE until “SURR OFF” appears in step 2. The HALL and SURROUND indicators go off.

Speaker arrangements for Dolby Surround

The following illustrations show how to obtain the optimum sound environment for various Dolby Surround settings. Try to find the speaker direction and location to create the optimum sound field.

CASE 1 When you have added a center speaker and rear speakers

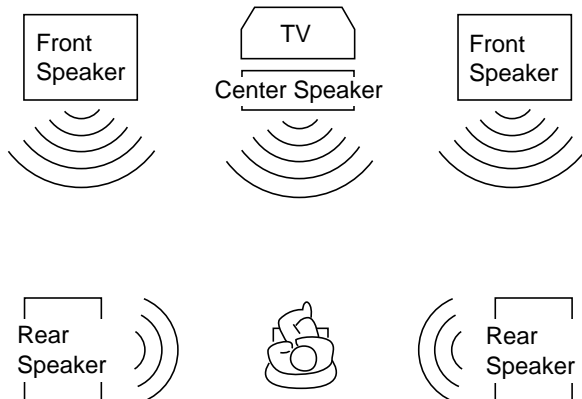

In this case:

1. Select "PROLOGIC."
2. Select "NORMAL" or "WIDE" for center mode.

See pages 27 to 29 for more details.

CASE 2 When you have added rear speakers (without a center speaker)

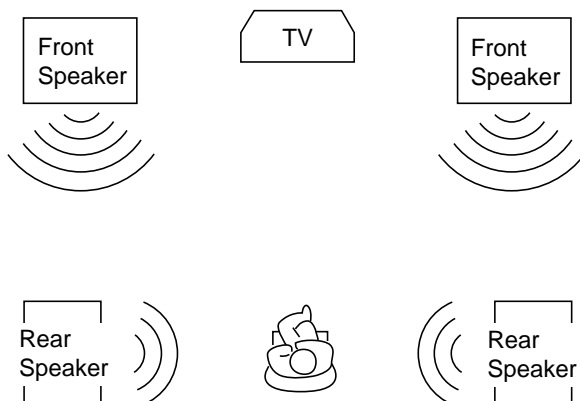

In this case:

1. Select "PROLOGIC."
2. Select "PHANTOM" for center mode.

See pages 27 to 29 for more details.

CASE 3 When you have added a center speaker (without rear speakers)

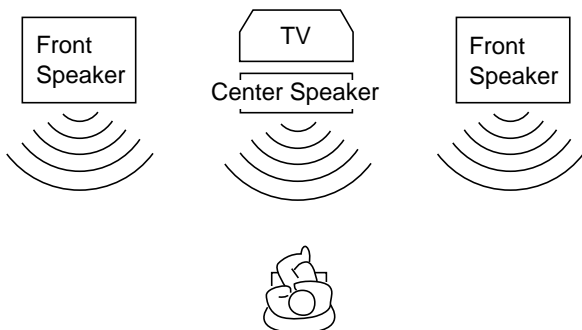

In this case:

1. Select "3CHLOGIC."
2. Select "NORMAL" or "WIDE" for center mode.

See pages 27 to 29 for more details.



The receiver memorizes two sets of Dolby Surround adjustments; one for Pro Logic and the other for 3ch Logic.

On the front panel:

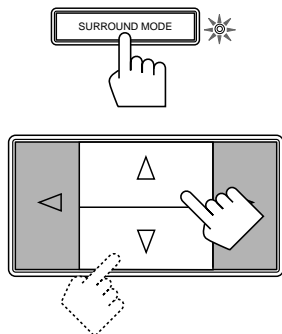

1. Press **SURROUND MODE** so that the Control Δ / ∇ buttons work for selecting the surround modes.

The lamp next to the button lights up.

2. Press Control Δ / ∇ until “**PROLOGIC**” or “**3CHLOGIC**” whichever you want appears on the display.

The PRO LOGIC or 3CH LOGIC indicator (as well as the SURROUND indicator) also lights up. Each time you press the button, the surround modes change as follows (the indicator of the selected surround mode also lights up on the display):

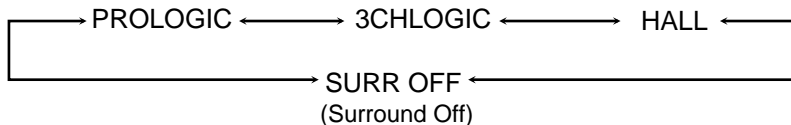

PROLOGIC:	Select this mode to watch a video source with Dolby Surround when you have connected the rear speakers (and a center speaker).
3CHLOGIC:	Select this mode to watch a video source with Dolby Surround when you have connected a center speaker and no rear speakers.
HALL:	This is JVC's original surround mode, and is different from Dolby Surround. To use this, see page 24.
SURR OFF:	No surround mode is applied.

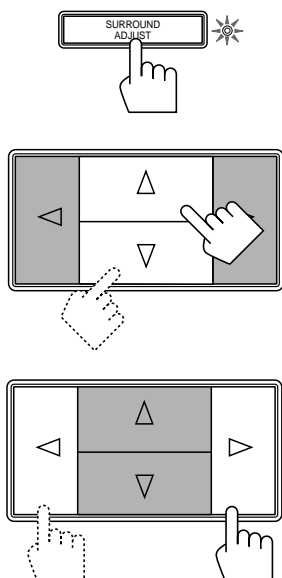

3. Press **SURROUND ADJUST** so that the Control Δ / ∇ / \triangleleft / \triangleright buttons work for adjusting the selected surround mode.

The lamp next to the button lights up.

4. Press Control Δ / ∇ until “**CNT MODE**” (Center Mode) appears on the display.

5. Press Control \triangleleft / \triangleright to select the center mode.

Each time you press the button, the center modes change as follows:

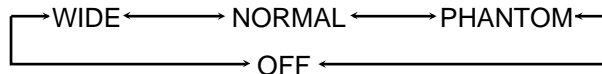

WIDE:	Select this mode when the center speaker can reproduce the bass better than the front speakers. All signals of the center channel are output through the center speaker.
NORMAL:	Select this mode when the center speaker cannot reproduce the bass better than the front speakers. The bass portions of the center channel signals are output through the front speakers.
PHANTOM:	Select this mode when you do not use a center speaker. The center speaker channel signals are output through the front speakers.
OFF:	Select this mode to turn off the center speaker channel.

Notes:

- If you have already set the center speaker size following the procedure described on page 16, you do not have to select the center mode in this procedure.
- When you have selected “3CHLOGIC,” you cannot select “PHANTOM.”

Front panel

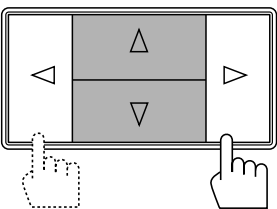
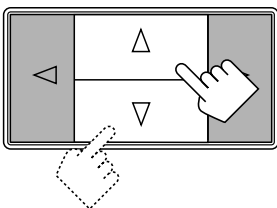
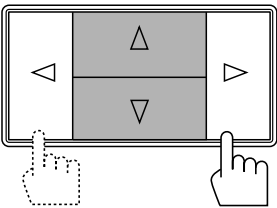
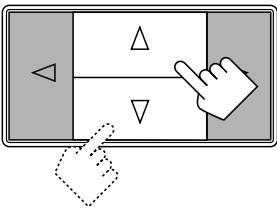
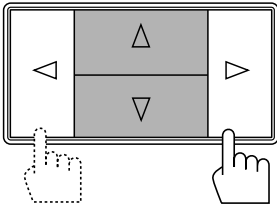
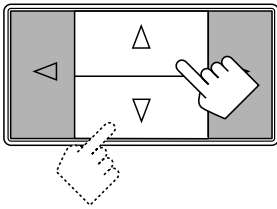

Front panel

6. Press Control Δ / ∇ until “-DELAY +” appears on the display.

7. Press Control $\triangleleft / \triangleright$ to adjust the delay time of the rear speaker output.

Each time you press the button, the delay time changes as follows:

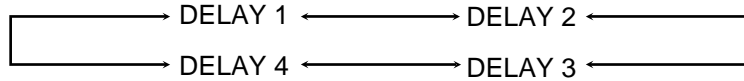

DELAY 1:	Select this when the distance from you to your rear speakers is greater than that to the front speakers.
DELAY 2:	Select this when the distance from you to your rear speakers is almost equal to that to the front speakers.
DELAY 3:	Select this when the distance from you to your rear speakers is a little less than that to the front speakers.
DELAY 4:	Select this when the distance from you to your rear speakers is much less than that to the front speakers.

Note:

When you have selected “3CHLOGIC,” you cannot adjust the delay time.

8. Press Control Δ / ∇ until “TEST” appears on the display, then press Control $\triangleleft / \triangleright$ to start checking the speaker output balance.

“TEST” starts flashing on the display, and a test tone comes out of the speakers in the following order:

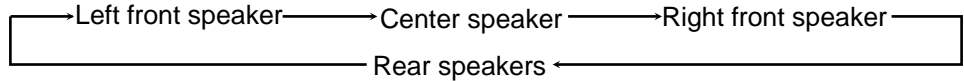

Notes:

- No test tone comes out of the rear speakers when you have selected “3CHLOGIC.”
- No test tone comes out of the center speaker when you select “PHANTOM” or “OFF” for the center mode.

9. If necessary, adjust the speaker output balance as follows:

- To adjust the rear speaker output level, press Control Δ / ∇ until “- REAR +” appears on the display, then press Control $\triangleleft / \triangleright$.
- To adjust the center speaker output level, press Control Δ / ∇ until “-CENTER+” appears on the display, then press Control $\triangleleft / \triangleright$.

Notes:

- You cannot adjust the left and right rear speakers output level separately.
- You cannot adjust the rear speakers output level when you have selected “3CHLOGIC.”
- You cannot adjust the center speaker output level when you select “PHANTOM” or “OFF” for the center mode.

10. Press Control Δ / ∇ until “TEST” appears on the display, then press Control $\triangleleft / \triangleright$ to stop the test tone.

11. Press Control Δ / ∇ until “CNT TONE” (Center Tone) appears on the display.

12. Press Control $\triangleleft / \triangleright$ to select the center tone you want.

The center tone adjustment affects the mid-frequency range, which the human voice is mostly made up of.

Each time you press the button, the display changes to show the following:



To make the dialogue clearer, select “SHARP1” (little) or “SHARP2” (much).

To make the dialogue softer, select “SOFT1” (little) or “SOFT2” (much).

When “FLAT” is selected, no adjustment is applied.

Note:

The center tone cannot be adjusted when sounds do not come out of the center speaker.

From the remote control:

Note:

If you want to use the remote control for adjusting the center mode and the center tone, use the menu function (see page 34).



1. Press SOUND CONTROL.

The remote control is activated for adjusting the sound.

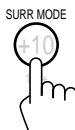

2. Press SURR MODE until "PROLOGIC" or "3CHLOGIC" whichever you want appears on the display.

The PRO LOGIC or 3CH LOGIC indicator (as well as the SURROUND indicator) also lights up. Each time you press the button, the surround modes change as follows (the indicator of the selected surround mode also lights up on the display):

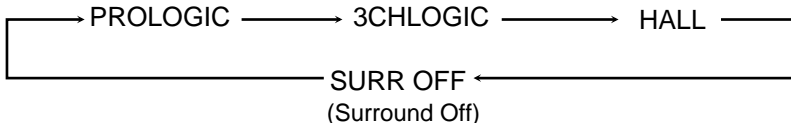

3. Press DELAY to adjust the delay time of the rear speaker output.

Each time you press the button, the delay time changes as follows:

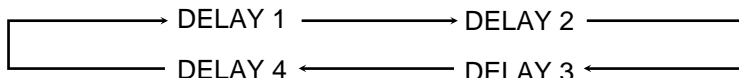

Note:

When you have selected "3CHLOGIC," you cannot adjust the delay time.



4. Press TEST to start checking the speaker output balance.

"TEST" starts flashing on the display, and a test tone comes out from the speakers in the following order:

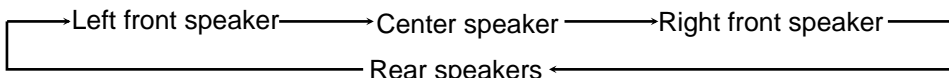

Notes:

- No test tone comes out of the rear speakers when you have selected "3CHLOGIC."
- No test tone comes out of the center speaker when you select "PHANTOM" or "OFF" for the center mode.

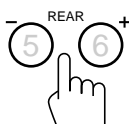

5. If necessary, adjust the speaker output balance as follows:

- To adjust the rear speaker output level, press REAR +/-.
- To adjust the center speaker output level, press CNTR +/-.

Pressing - decreases the output level up to -10 dB.

Pressing + increases the output level up to +10 dB.

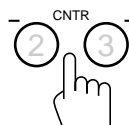

Notes:

- You cannot adjust the left and right rear speakers output level separately.
- You cannot adjust the rear speakers output level when you have selected "3CHLOGIC."
- You cannot adjust the center speaker output level when you select "PHANTOM" or "OFF" for the center mode.



6. Press TEST again to stop the test tone.

Remote Control



Using Dolby Surround

Once you have set the Dolby Surround adjustments you can use the same adjustments every time you want to enjoy Dolby Surround.

The receiver memorizes two sets of Dolby Surround adjustments; one for Pro Logic and the other for 3ch Logic.

On the front panel:

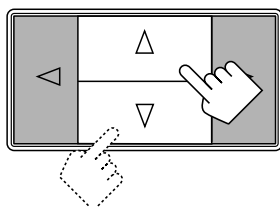
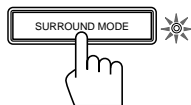

Front Panel

1. Press SURROUND MODE so that the Control Δ / ∇ buttons work for selecting the surround modes.

The lamp next to the button lights up.

2. Press Control Δ / ∇ until "PROLOGIC" or "3CHLOGIC" whichever you want appears on the display.

The PRO LOGIC or 3CH LOGIC indicator (as well as the SURROUND indicator) also lights up.

Each time you press the button, the surround modes change as follows (the indicator of the selected surround mode also lights up on the display):

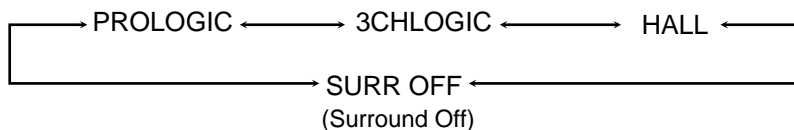

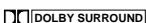
3. Select and play a sound source which was processed with Dolby Surround and is labeled with  mark.

To cancel Dolby Surround, press Control Δ / ∇ until "SURR OFF" appears in step 2 above. The indicator of the selected mode and the SURROUND indicator go off.

From the remote control:



Remote Control

1. Press SOUND CONTROL.

The remote control is activated for adjusting the sound.

2. If necessary, press SURR MODE until "PROLOGIC" or "3CHLOGIC" whichever you want appears on the display.

The PRO LOGIC or 3CH LOGIC indicator (as well as the SURROUND indicator) also lights up.

Each time you press the button, the surround modes change as follows (the indicator of the selected surround mode also lights up on the display):

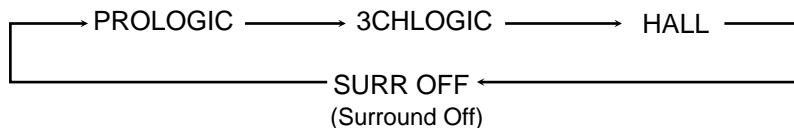

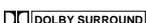
3. Select and play a sound source which was processed with Dolby Surround and is labeled with  mark.

To cancel Dolby Surround, press SURR MODE until "SURR OFF" appears in step 2 above. The indicator of the selected mode and the SURROUND indicator go off.

Using the On-Screen Display to Control the Receiver

You can use the menu function on the TV screen to control the receiver.

To use this function, you need to connect the TV to the MONITOR OUT jack on the rear panel (see page 9), and set the TV's input mode to the appropriate position to which the receiver is connected.

When the TV's input mode is for TV, you cannot see the on-screen display.

IMPORTANT:

When you use the menu functions, make sure that you have connected a TV and operate the menu function while watching the on-screen displays on the TV.

Basic Procedures

Menu function buttons

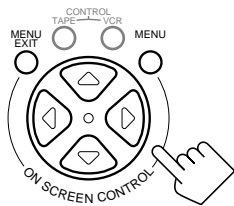

MAIN MENU

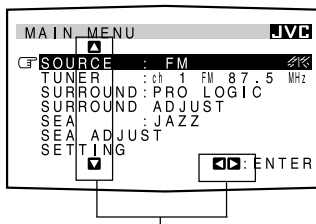

Shows the buttons you can use on the current menu. In this case, press Δ / ∇ to move \square up and down, and $\triangleleft / \triangleright$ to select the item. (The menus are shown on the TV for about one minute.)

From the remote control:

1. Press MENU.

The MAIN MENU appears on the TV screen.

- If you press $\Delta / \nabla / \triangleleft / \triangleright$, a sub-menu you can adjust at that time appears on the TV screen instead of the MAIN MENU.

2. Press Δ / ∇ to move \square to the sub-menu you want to set, then press $\triangleleft / \triangleright$.

The sub-menu you want appears.

3. If necessary, press $\Delta / \nabla / \triangleleft / \triangleright$ to set or adjust the item you want on the selected sub-menu.

When a item is selected, the item will be highlighted.

Note:

Moving \square to an item does not mean that you have selected it. If the item is not highlighted, press $\triangleleft / \triangleright$ to highlight it.

4. When you finish, press MENU EXIT.

The menu disappears from the TV.

To go back to the MAIN MENU any time during the process

Press MENU again.

Selecting the Source to Play (Also see page 11)

1. Press MENU.

The MAIN MENU appears on the TV.

2. Press Δ / ∇ to move \square to "SOURCE," then press $\triangleleft / \triangleright$.

The SOURCE menu appears.

3. Press Δ / ∇ to move \square to the source you want to play.

4. When you finish, press MENU EXIT.

The menu disappears from the TV.

SOURCE menu

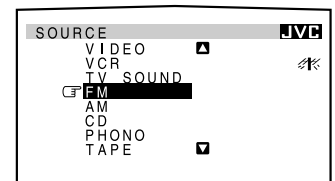

Adjusting the Front Speaker Output Balance (Also see page 14)

1. Press MENU.

The MAIN MENU appears on the TV.

2. Press Δ / ∇ to move \square to "SETTING," then press $\triangleleft / \triangleright$.

The SETTING menu appears.

3. Press Δ / ∇ to move \square to "BAL." (Balance).

4. Press $\triangleleft / \triangleright$ repeatedly to adjust the balance.

5. When you finish, press MENU EXIT.

The menu disappears from the TV.

SETTING menu

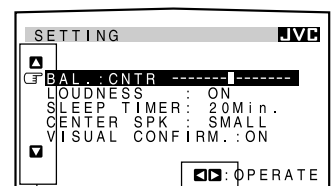

Shows the buttons you can use on the current menu.

In this case, press Δ / ∇ to move \square up and down, and $\triangleleft / \triangleright$ to adjust or set the item.

■ Listening at Low Volume (Loudness) (Also see page 14)

1. Press **MENU**.
The MAIN MENU appears on the TV.
2. Press Δ / ∇ to move \leftarrow to “SETTING,” then press $\triangleleft / \triangleright$.
The SETTING menu appears.
3. Press Δ / ∇ to move \leftarrow to “LOUDNESS.”
4. Press $\triangleleft / \triangleright$ to set the loudness function to “ON” or “OFF.”
5. When you finish, press **MENU EXIT**.
The menu disappears from the TV.

SETTING menu

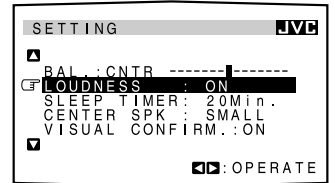

■ Using the Sleep Timer (Also see page 15)

1. Press **MENU**.
The MAIN MENU appears on the TV.
2. Press Δ / ∇ to move \leftarrow to “SETTING,” then press $\triangleleft / \triangleright$.
The SETTING menu appears.
3. Press Δ / ∇ to move \leftarrow to “SLEEP TIMER.”
4. Press $\triangleleft / \triangleright$ to set the shut-off time.
5. When you finish, press **MENU EXIT**.
The menu disappears from the TV.

SETTING menu

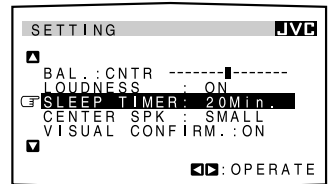

■ Selecting the Center Speaker Size (Also see page 16)

Note:

When the surround mode is Hall or off, you cannot select the center speaker size.

1. Press **MENU**.
The MAIN MENU appears on the TV.
2. Press Δ / ∇ to move \leftarrow to “SETTING,” then press $\triangleleft / \triangleright$.
The SETTING menu appears.
3. Press Δ / ∇ to move \leftarrow to “CENTER SPK” (Center Speaker).
4. Press $\triangleleft / \triangleright$ repeatedly until the appropriate center speaker size is selected.
5. When you finish, press **MENU EXIT**.
The menu disappears from the TV.

SETTING menu

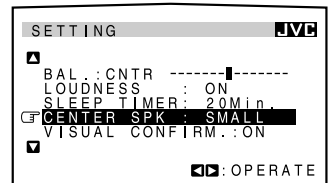

■ Using Visual Confirmation (Also see page 17)

1. Press **MENU**.
The MAIN MENU appears on the TV.
2. Press Δ / ∇ to move \leftarrow to “SETTING,” then press $\triangleleft / \triangleright$.
The SETTING menu appears.
3. Press Δ / ∇ to move \leftarrow to “VISUAL CONFIRM.” (Visual Confirmation).
4. Press $\triangleleft / \triangleright$ to set Visual Confirmation to “ON” or “OFF.”
5. When you finish, press **MENU EXIT**.
The menu disappears from the TV.

SETTING menu

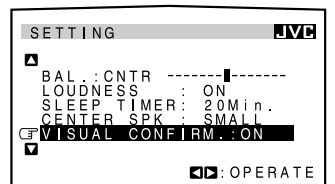

■ Operating the Tuner

1. **Press MENU.**
The MAIN MENU appears on the TV.
2. **Press Δ / ∇ to move \leftarrow to “TUNER,” then press $\triangleleft / \triangleright$.**
The TUNER menu appears.
3. **Press Δ / ∇ to move \leftarrow to the item you want to set or adjust, then press $\triangleleft / \triangleright$.**
On the TUNER menu, you can do the following:
 - “CH.”: Select a preset channel station. (See page 20)
If you want to assign a name to a preset channel, see page 21.
 - “BAND”:
 - “TUNING”:
 - “FM MODE”:
4. **When you finish, press MENU EXIT.**
The menu disappears from the TV.

TUNER menu

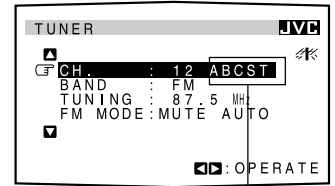

If you have assigned the name to this preset station, it appears here.

■ Selecting Your Favorite SEA Mode (Also see page 22)

1. **Press MENU.**
The MAIN MENU appears on the TV.
2. **Press Δ / ∇ to move \leftarrow to “SEA,” then press $\triangleleft / \triangleright$.**
The SEA MODE menu appears.
3. **Press Δ / ∇ to move \leftarrow to the SEA mode you want.**
4. **When you finish, press MENU EXIT.**
The menu disappears from the TV.

SEA MODE menu

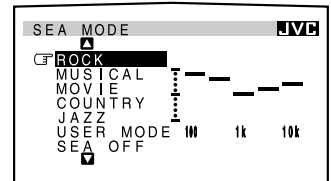

■ Creating Your Own SEA Mode (Also see page 23)

1. **Press MENU.**
The MAIN MENU appears on the TV.
2. **Press Δ / ∇ to move \leftarrow to “SEA ADJUST” then press $\triangleleft / \triangleright$.**
The SEA ADJUST menu appears.
3. **Press $\Delta / \nabla / \triangleleft / \triangleright$ to adjust the SEA mode as you want.**
 $\triangleleft / \triangleright$: Select the frequency ranges.
 Δ / ∇ : Adjust the frequency levels.
4. **Press MEMORY (next to the SEA ADJUST button).**
5. **When you finish, press MENU EXIT.**
The menu disappears from the TV.

SEA ADJUST menu

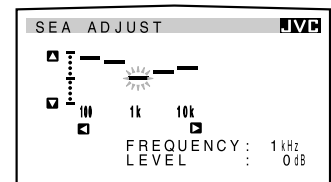

■ Selecting the Surround Modes (Also see pages 24)

1. **Press MENU.**
The MAIN MENU appears on the TV.
2. **Press Δ / ∇ to move \leftarrow to “SURROUND,” then press $\triangleleft / \triangleright$.**
The SURROUND MODE menu appears.

3. **Press Δ / ∇ to move \leftarrow to one of the surround modes.**

If you want to adjust the selected mode, go to the following steps.

4. **Press MENU.**
The MAIN MENU appears on the TV again.
5. **Press Δ / ∇ to move \leftarrow to “SURROUND ADJUST,” then press $\triangleleft / \triangleright$.**
The adjustment menu for the mode you have selected in step 3 appears.
6. **Press Δ / ∇ to move \leftarrow to the item you want to set or adjust, then press $\triangleleft / \triangleright$.**
On these adjustment menus, you can do the following:

For HALL:

- “REAR”: Adjust the rear speaker output level.
- “DELAY”: Adjust the delay time of the rear speaker sound.

For Dolby Pro Logic:

- “CENTER MODE”: Select the center mode.
- “TEST”: Output a test tone.
- “CENTER”: Adjust the center speaker output level.
- “REAR”: Adjust the rear speaker output level.
- “DELAY”: Adjust the delay time of the rear speaker sound.
- “CENTER TONE”: Select the center tone.

For Dolby 3ch Logic:

- “CENTER MODE”: Select the center mode.
- “TEST”: Output a test tone.
- “CENTER”: Adjust the center speaker output level.
- “CENTER TONE”: Select the center tone.

7. **When you finish, press MENU EXIT.**
The menu disappears from the TV.

SURROUND MODE menu

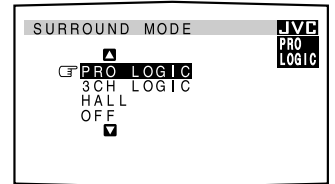

HALL adjustment menu

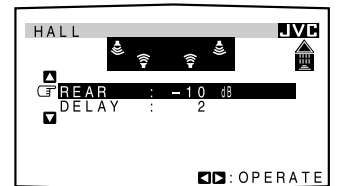

PRO LOGIC adjustment menu

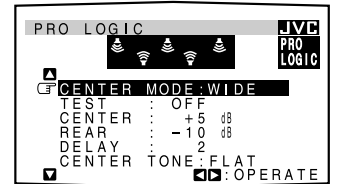

3CH LOGIC adjustment menu

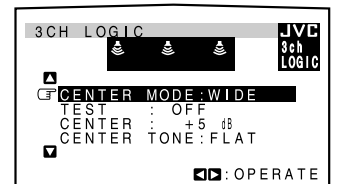

COMPU LINK Remote Control System

The COMPU LINK remote control system allows you to operate JVC audio components through the remote sensor on the receiver.

To use this remote control system, you need to connect JVC audio components through the COMPU LINK-3 (SYNCHRO) jacks (see below) in addition to the connections using cables with RCA pin plugs (see page 8).

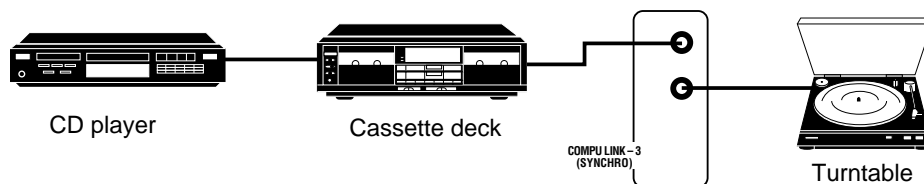

Notes:

- If your audio component has two COMPU LINK-3 (SYNCHRO) jacks, you can use either one. If it has only one COMPU LINK-3 (SYNCHRO) jack, connect it so that it is the last item in the series of components. (For example, the turntable or CD player in the diagram above.)
- Refer also to the manuals supplied with your audio components.

This remote control system allows you to use four functions listed below.

■ Remote Control through the Remote Sensor on the Receiver

You can control the connected audio components through the remote sensor on the receiver using this remote control. For details, see pages 38 and 39.

Note:

Aim the remote control directly at the remote sensor on the receiver.

■ Automatic Source Selection

When you press the play (▶) button on a connected component or on its own remote control, the receiver automatically turns on and changes the source to the component. On the other hand, if you select a new source on the receiver or the remote control, the selected component begins playing immediately.

In both cases, the previously selected source continues playing without sound for a few seconds.

■ Automatic Power On/Off (only possible with the COMPU LINK-3 connection)

Both the CD player and cassette deck turn on and off along with the receiver.

When you turn on the receiver, the CD player or cassette deck will turn on automatically, depending on which component has been previously selected.

When you turn off the receiver, both the CD player and cassette deck will turn off.

■ Synchronized Recording

Synchronized recording means the cassette deck starts recording as soon as a CD or a record begins playing.

To use synchronized recording, follow these steps:

- 1 Put a tape in the cassette deck, and a disc in the CD player (or a record on the turntable).
- 2 Press the record (●) button and the pause (||) button on the cassette deck at the same time. This puts the cassette deck into recording pause.

Note:

If you do not press the record (●) button and pause (||) button at the same time, the synchronized recording feature will not operate.

- 3 Press the play (▶) button on the CD player or on the turntable.

The source changes on the receiver, and as soon as play starts, the cassette deck starts recording.

When the play ends, the cassette deck enters recording pause, and stops about 4 seconds later.

Notes:

- During synchronized recording, the selected source cannot be changed.
- If your CD player is playing in program mode, a 4-second blank is recorded between tracks so that the music scan feature of your cassette deck can be used on the recorded tape.
- If the power of any component is shut off during synchronized recording, the COMPU LINK remote control system may not operate properly. In this case, you must start again from the beginning.

AV COMPU LINK Remote Control System

The AV COMPU LINK remote control system allows you to operate JVC video components (TV and VCR) through the receiver.

CONNECTIONS:

To use this remote control system, you need to connect the video components you want to operate, following the procedures below.

CAUTION:

The AV COMPU LINK remote control system cannot control the video components connected to the VIDEO jacks on the receiver. Use only VCR jacks for the VCR jacks.

1. Connect your VCR and TV as follows, using the cables with the monaural mini-plugs (not supplied).

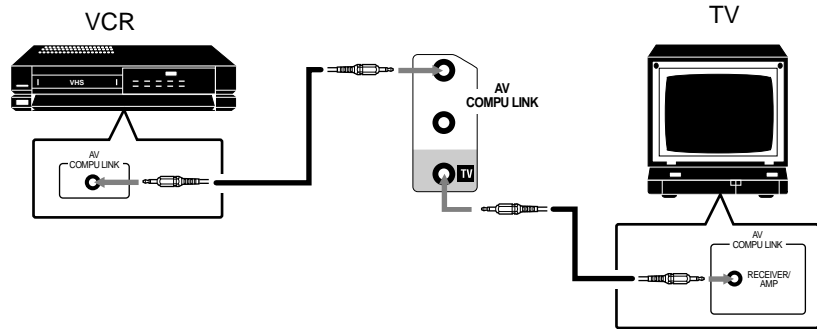

2. Connect the VCR and TV as follows.

- When using an S-VHS VCR, connect it as follows: See also page 9.

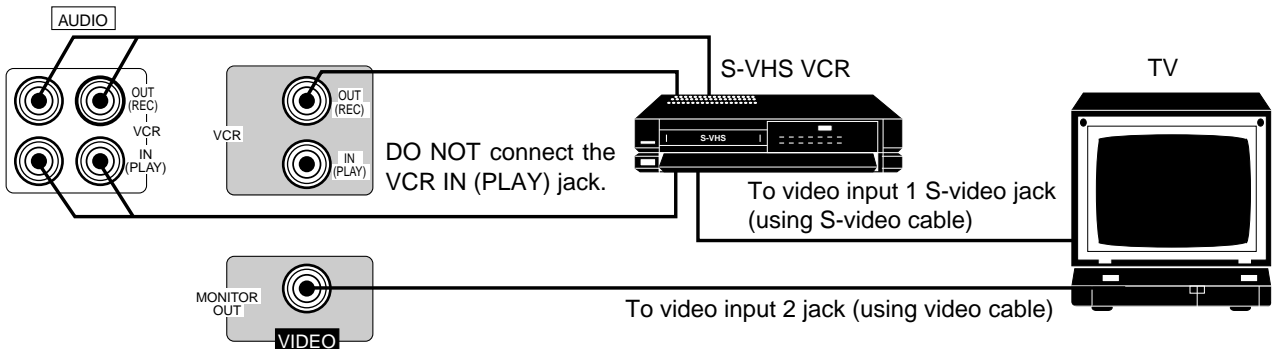

- When using a VHS VCR, connect it as follows: See also page 9.

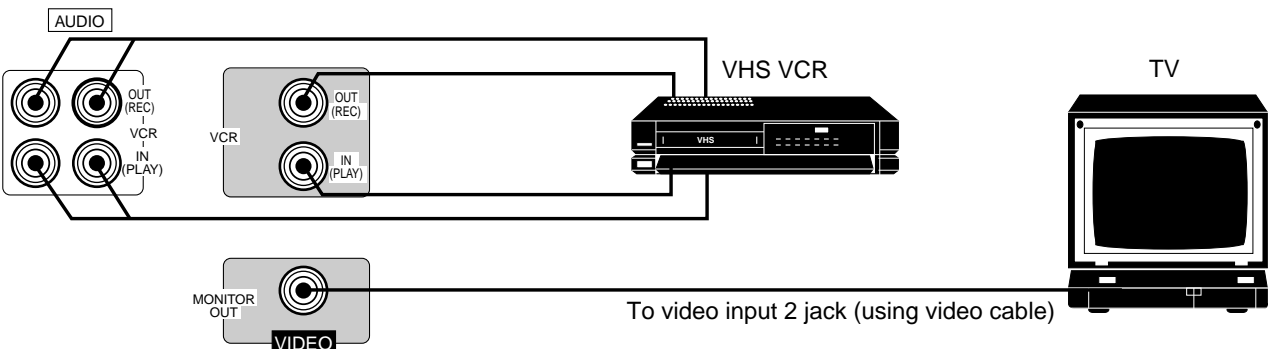

3. When turning on the TV for the first time after the AV COMPU LINK connection, turn the TV volume to the minimum using the TV volume control on the TV.

FUNCTIONS:

This remote control system allows you to use four functions listed below.

Note:

Refer also to the manuals supplied with your video components.

■ Remote Control of the TV through the Remote Sensor on the Receiver

You can control the TV through the remote sensor on the receiver using this remote control.

For details, see page 39.

Note:

Aim the remote control directly at the remote sensor on the receiver when operating the TV. (However, to operate the VCR, always aim the remote control directly at the remote sensor on the VCR.)

■ One-Touch Video Play

Simply by inserting a video cassette without its safety tab into the VCR, you can enjoy the video playback without setting other switches manually.

The receiver automatically turns on and changes the source to “VCR.”

The TV automatically turns on and changes the input mode to the position you can view the VCR playback.

When you insert a video cassette with its safety tab, press the play (▶) button on the VCR or on the remote control. So, you can get the same result.

Note:

When you connect an S-VHS VCR as described on page 36, you cannot see the on-screen displays (such as Visual Confirmation and Menus) since the AV COMPULINK Remote Control System automatically changes the TV input mode to “Video input 1” when you operate the S-VHS VCR.

If you do not mind stopping watching the picture, you can then show the on-screen displays after changing the TV input mode to the position (Video input 2) the receiver is connected to.

■ Automatic Selection of TV’s Input Mode

- When you select “TV SOUND” as the source to play on the receiver, the TV automatically changes the input mode to the TV tuner so that you can watch TV.
- When you select “VIDEO” as the source to play on the receiver, the TV automatically changes the input mode to the Video Input 2 so that you can watch the playback picture.
- When you select “VCR” as the source to play on the receiver, the TV automatically changes the input mode to the correct position (either Video Input 1 or 2) so that you can watch the playback picture.

Note:

When you select “TV SOUND” as the source on the receiver, you cannot see the on-screen displays (such as Visual Confirmation and the menu function) since the AV COMPULINK remote control system automatically changes the TV’ input mode to the TV tuner.

If you do not mind stopping listening to the TV sounds, you can then show the on-screen displays after changing the TV input mode to the position (Video input 2) the receiver is connected to.

■ Automatic Power On/Off

The TV and VCR turn on and off along with the receiver.

When you turn on the receiver;

- If the previously selected source is “VCR,” the TV and VCR will turn on automatically.
- If the previously selected source is “VIDEO” or “TV SOUND,” only the TV will turn on automatically.

When you turn off the receiver, the TV and VCR will turn off.

Note:

If you turn off the receiver while recording on the VCR, the VCR will not turn off, but continue recording.

Using the Remote Control for Operating JVC's Audio/Video Components

You can operate JVC's audio and video components with this receiver's remote control, since control signals for JVC components are preset in the remote control.

Notes:

- If you use the buttons on the front panel or the menu function to choose a source, the remote control will not operate that source. To operate a source with the remote control, the source must be selected using buttons on the remote control.
- Check to see if its remote control mode selector is set to the correct position. To operate audio system, TVs, and VCRs, set it to the "AUDIO/TV/VCR" position.
- Refer also to the manuals supplied with your components.

IMPORTANT:

To operate JVC's audio components using this remote control:

- You need to connect JVC audio components through the COMPU LINK-3 (SYNCHRO) jacks (see page 35) in addition to the connections using cables with RCA pin plugs (see page 8).
- Aim the remote control directly at the remote sensor on the receiver.

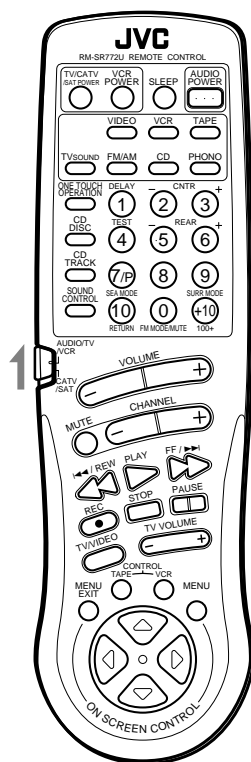

Tuner

After pressing FM/AM (with the remote control mode selector set to the "AUDIO/TV/VCR" position), you can perform the following operations:

FM/AM: Alternates between FM and AM.

1 — 10, +10: Selects a preset channel number directly.

For channel number 5, press 5. For channel number 15, press +10, then 5. For channel number 20, press +10, then 10.

FM MODE/MUTE: Changes the FM reception mode.

Sound control section (Amplifier)

After pressing SOUND CONTROL (with the remote control mode selector set to the "AUDIO/TV/VCR" position), you can perform the following operations:

SEA MODE: Changes the SEA modes.

SURR MODE: Changes the surround modes.

CNTR +/-: Changes the center speaker output level for the surround modes.

REAR +/-: Changes the left/right rear speaker output level for surround modes.

DELAY: Changes the delay time for surround modes.

TEST: Checks the speaker output level for surround modes.

Note:

After adjusting sounds, press the corresponding source selecting button (FM/AM, CD, CD TRACK, CD DISC, VCR or TV SOUND) to operate your target source by using 10 keys; otherwise, 10 keys cannot be used for operating your target source.

CD player

After pressing CD or CD TRACK (with the remote control mode selector set to the "AUDIO/TV/VCR" position), you can perform the following operations on a CD player:

PLAY: Starts playing.

◀◀: Returns to the beginning of the current (or previous) track.

▶▶: Skips to the beginning of the next track.

STOP: Stops playing.

PAUSE: Pauses playing. To release it, press PLAY.

1 — 10, +10: Selects a track number directly.

To select track number 5, press 5. For track number 15, press +10, then 5. For track number 20, press +10, then 10. For track number 30, press +10, +10, then 10.

Note:

You can use either the CD button or the CD TRACK button to activate the buttons listed above. If you press CD, the playing source also changes to "CD." On the other hand, if you press CD TRACK, the playing source does not change to "CD."

CD player-changer

After pressing CD DISC (with the remote control mode selector set to the "AUDIO/TV/VCR" position), you can perform the following operations on a CD player-changer:

PLAY: Starts playing.

◀◀: Returns to the beginning of the current (or previous) track.

▶▶: Skips to the beginning of the next track.

STOP: Stops playing.

PAUSE: Pauses playing. To release it, press the PLAY button.

1 — 6, 7/P: Select the number of a disc installed in a CD player-changer.

After pressing CD TRACK:

1 — 10, +10: Selects a track number directly.

To select track number 5, press 5. For track number 15, press +10, then 5. For track number 20, press +10, then 10. For track number 30, press +10, +10, then 10.

Turntable

After pressing PHONO (with the remote control mode selector set to the “AUDIO/TV/VCR” position), you can perform the following operations on a turntable:

- PLAY:** Starts playing.
STOP: Stops playing.

Cassette deck

After pressing TAPE or TAPE CONTROL (with the remote control mode selector set to the “AUDIO/TV/VCR” position), you can perform the following operations on a cassette deck:

- PLAY:** Starts playing.
REW: First rewinds the tape from right to left.
FF: First rewinds the tape from left to right.
STOP: Stops operations.
PAUSE: Pauses playing or recording temporarily. To release it, press the PLAY button.
REC ●: Press this button with the PLAY button to start recording.
Press this button with the PAUSE button to enter recording pause (standby).

Note:

You can use either the TAPE button or the TAPE CONTROL button to activate the buttons listed above. If you press TAPE, the playing source also changes to “TAPE.” On the other hand, if you press TAPE CONTROL, the playing source does not change to “TAPE.”

IMPORTANT:

To operate JVC’s video components using this remote control:

- You need to connect JVC video components through the AV COMPU LINK jacks (see page 36) in addition to the connections using cables with RCA pin plugs (see pages 9 and 36).
 - When operating the VCR, aim the remote control directly at the remote sensor on the VCR.
 - When operating the TV, aim the remote control directly at the remote sensor on the receiver.
-

VCR

After pressing VCR or VCR CONTROL (with the remote control mode selector set to the “AUDIO/TV/VCR” position), you can perform the following operations on the VCR:

- PLAY:** Starts playing.
REW: Rewinds a tape.
FF: Fast winds a tape.
STOP: Stops operations.
PAUSE: Pauses playing or recording temporarily. To release it, press the PLAY button.
REC ●: Press this button with the PLAY button to start recording.
Press this button with the PAUSE button to enter recording pause (standby).
CHANNEL +/-: Changes the channels on the VCR.
1 – 9, 0: Selects the channels on the VCR.

Notes:

- You can use either the VCR button or the VCR CONTROL button to activate the buttons listed above. If you press VCR, the playing source also changes to “VCR.” On the other hand, if you press VCR CONTROL, the playing source does not change to “VCR.”
 - You can also turn the VCR on and off by pressing VCR POWER on the remote control.
-

TV

After pressing TV SOUND (with the remote control mode selector set to the “AUDIO/TV/VCR” position), you can perform the following operations on a TV:

- CHANNEL +/-:** Changes the channels.
TV VOLUME +/-: Adjusts the volume.
1 – 9, 0, 100+: Selects the channels.
TV/VIDEO: Sets the input mode (either TV or VIDEO).
RETURN: Alternates between the previously selected channel and the current channel.

Note:

You can also turn the TV on and off by pressing TV/CATV/SAT POWER on the remote control.

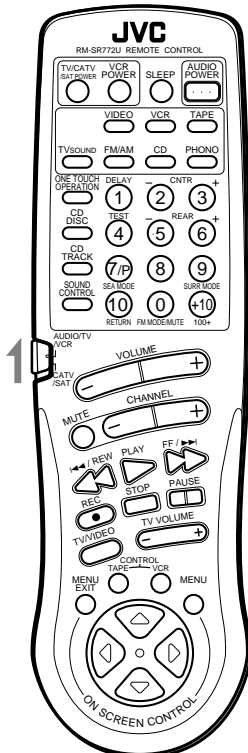

Operating Other Manufacturers' VCR, TV, CATV Converter, and Satellite Tuners

This remote control supplied with the receiver can transmit control signals for other manufacturers' VCRs, TVs and CATV converters. By changing the transmittable signals from preset ones to the other manufacturers', you can operate the other manufacturer's components using this remote control.

When operating the other manufacturers' components, refer also to the manuals supplied with them. To operate these components with the remote control, first you need to set the manufacturer's code each for VCR, TV, CATV converters, and satellite tuner.

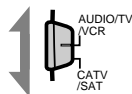

IMPORTANT

When using the Remote Control, check to see if its remote control mode selector is set to the correct position:

To operate an audio system, TV, and VCR, set it to the "AUDIO/TV/VCR" position.

To operate a CATV converter and satellite tuner, set it to the "CATV/SAT" position.

To change the transmittable signals for operating another manufacturer's TV

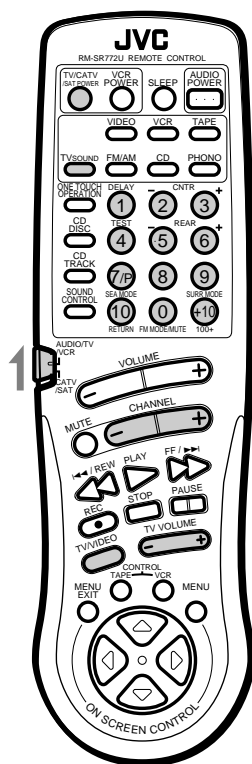

1. Set the remote control mode selector to the "AUDIO/TV/VCR" position.

2. Press and hold TV/CATV/SAT POWER.

3. Press TV SOUND.

4. Enter the manufacturer's code (three digits) using buttons 1 – 9, and 0.

See the lists on page 42 to find the code.

5. Release TV/CATV/SAT POWER.

The following buttons can be used for operating the TV (with the remote control mode selector set to the "AUDIO/TV/VCR" position):

TV/CATV/SAT POWER: Turns on and off TV.

After pressing TV SOUND you can perform the following operations on the TV:

CHANNEL +/-: Changes the channels.

TV VOLUME +/-: Adjusts the volume.

1 – 10, 0, +10: Selects the TV channels.

+10 button will function as the ENTER button if your TV requires pressing ENTER after selecting a channel number.

TV/VIDEO: Sets the input mode (either TV or VIDEO).

Note:

Refer also to the manual supplied with your TV.

6. Try to operate your TV by pressing TV/CATV/SAT POWER.

When your TV turns on or off, you have entered the correct code.

7. If there are more than one code listed for your brand of TV, try each one until the correct one is entered.

To change the transmittable signals for operating a CATV converter or satellite tuner

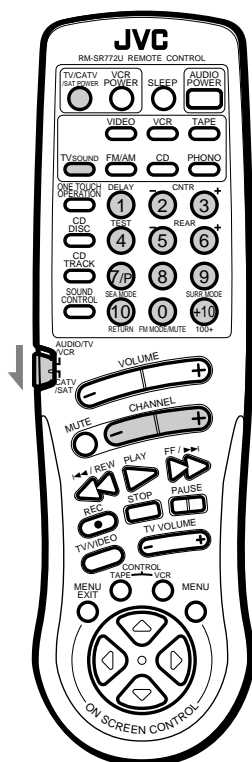

1. Set the remote control mode selector to the “CATV/SAT” position.
2. Press and hold TV/CATV/SAT POWER.
3. Press TV SOUND.
4. Enter the manufacturer’s code (three digits) using buttons 1 – 9, and 0.
See the lists on page 43 to find the code.
5. Release TV/CATV/SAT POWER.

After setting the remote control mode selector to the “CATV/SAT” position, you can perform the following operations on the CATV converter or on the satellite tuner:

- TV/CATV/SAT POWER:** Turns on and off the CATV converter or satellite tuner.
- CHANNEL +/-:** Changes the channels.
- 1 – 10, 0, +10:** Selects the channels.
+10 button will function as the ENTER button if your CATV converter or satellite tuner requires pressing ENTER after selecting a channel number.

Note:
Refer also to the manual supplied with your CATV converter or satellite tuner.

6. Try to operate your CATV converter or satellite tuner by pressing TV/CATV/SAT POWER.
When your CATV converter or satellite tuner turns on or off, you have entered the correct code.
7. If there are more than one code listed for your brand of CATV converter or satellite tuner, try each one until the correct one is entered.

To change the transmittable signals for operating another manufacturer’s VCR

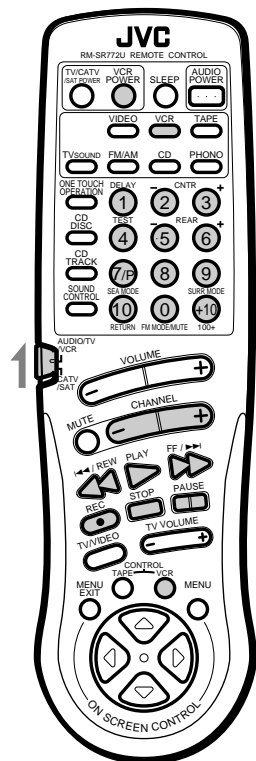

1. Set the remote control mode selector to the “AUDIO/TV/VCR” position.
2. Press and hold VCR POWER.
3. Press VCR.
4. Enter the manufacturer’s code (three digits) using buttons 1 – 9, and 0.
See the lists on page 44 to find the code.
5. Release VCR POWER.

The following buttons can be used for operating the VCR:

- VCR POWER:** Turns on and off VCR.
- After pressing VCR or VCR CONTROL (with the remote control mode selector set to the “AUDIO/TV/VCR” position), you can perform the following operations on the VCR:
- CHANNEL +/-:** Changes the channels on the VCR.
- 1 – 10, 0, +10:** Selects the channels on the VCR.
+10 button will function as the ENTER button if your VCR requires pressing ENTER after selecting a channel number.
- PLAY:** Starts playback.
- STOP:** Stops operations.
- PAUSE:** Pauses.
- REW:** Rewinds a tape.
- FF:** Fast winds a tape.
- REC ●:** Starts recording or enters recording pause.

Notes:

- You can use either the VCR button or the VCR CONTROL button to activate the buttons listed above. If you press VCR, the playing source also changes to “VCR.” On the other hand, if you press VCR CONTROL, the playing source does not change to “VCR.”
- Refer also to the manual supplied with your VCR.

6. Try to operate your VCR by pressing VCR POWER.
When your VCR turns on or off, you have entered the correct code.
7. If there are more than one code listed for your brand of VCR, try each one until the correct one is entered.

Manufacturers' codes for TV

Admiral	093	Majestic	016
Adventura	046	Marantz	030, 054
Aiko	092	Matsushita	250
Akai	030	Megatron	145, 178
Alleron	179	Memorex	016, 056, 150, 154, 178
Ambassador	177	MGA	019, 030, 150, 178
Anam	180	Midland	017, 039, 047, 051, 135
Anam National	055	Minutz	021
AOC	019, 030	Mitsubishi	019, 093, 150, 178
Audiovox	180	Motorola	055, 093
Belcor	019	MTC	019, 030, 056, 060
Bell & Howell	016, 154	Multitech	180
Bradford	180	NAD	156, 166, 178
Brockwood	019	NEC	019, 030, 056
Candle	030, 046, 056	Nikko	030, 092, 178
Carnivale	030	Noshi	018
Carver	054	NTC	092
Celebrity	000	Onwa	180
Citizen	030, 039, 046, 056, 060, 092, 280	Optimus	154, 166, 250
Concerto	056	Optonica	093, 165
Contec	180	Orion	236
Craig	180	Panasonic	051, 055, 250
Crown	039, 180	Penney	018, 019, 021, 030, 039, 047, 051, 060, 135, 149, 156, 178
Curtis Mathes	030, 039, 060, 154	Philco	019, 020, 030, 054
CXC	180	Philips	054
Daewoo	019, 039, 092, 451	Pilot	019, 030, 039
Daytron	019	Pioneer	166
Dumont	017, 019	Portland	019, 039, 092
Electroband	000	Prism	051
Emerson	019, 039, 154, 177, 178, 179, 180, 236, 280, 282, 463	Proscan	047
Envision	030	Proton	178
Fisher	154, 159	Pulsar	017, 019
Fujitsu	179	Quasar	051, 055, 165, 250
Funai	171, 179, 180	Radio Shack	019, 030, 039, 047, 056, 154, 165, 178, 180
Futuretech	180	RCA	018, 019, 047, 090, 135
GE	021, 047, 051, 055, 135, 178, 282, 451	Realistic	019, 030, 039, 056, 154, 165, 178, 180
Gibralter	017, 019, 030	Runco	017, 030
GoldStar	019, 030, 039, 056, 178	Sampo	030, 039
Grunpy	179, 180	Samsung	019, 030, 039, 056, 060, 178
Hallmark	178	Samsux	039
Harvard	180	Sanyo	154, 159
Hitachi	056, 145, 151	Scimitsu	019
Infinity	054	Scotch	178
Janeil	046	Scott	019, 178, 179, 180, 236
JBL	054	Sears	047, 054, 056, 149, 154, 156, 159, 171, 178, 179
JCB	000	Sharp	039, 093, 165
JVC	053, 069, 160, 169	Shogun	019
KEC	180	Signature	016
Kenwood	019, 030	Simpson	187
Kloss	046	Sony	000
KTV	030, 039, 180, 280	Soundesign	178, 179, 180
Logik	016	Squareview	171
Luxman	056	SSS	019, 180
LXI	047, 054, 154, 156, 178		
Magnavox	020, 030, 054, 187		

Manufacturers' codes for CATV converters

Starlite	180
Supre-Macy	046
Supreme	000
Sylvania	020, 030, 054
Symphonic	171
Tandy	093
Tatung	055
Technics	051, 250
Technol Ace	179
Techwood	051, 056
Teknika	016, 019, 039, 054, 056, 060, 092, 150, 179, 180
TMK	056, 177, 178
Toshiba	060, 149, 154, 156
Totevision	039
Vector Research	030
Victor	053
Vidikron	054
Vidtech	019, 178
Viking	046
Wards	016, 019, 020, 021, 030, 054, 056, 165, 178, 179
Yamaha	019, 030
Zenith	016, 017

ABC	003, 007, 008, 011, 013, 014, 017
Archer	153, 797
Century	153
Citizen	153
Comtronics	040
Contec	019
Everquest	015, 040
Focus	400
Garrard	153
Gemini	015
General Instrument	011, 276
GoldStar	040, 144
Hamlin	009, 020, 259, 273
Hitachi	011
Hytex	007
Jasco	153
Jerrold	003, 011, 012, 014, 015, 276
Memorex	000
Novaplex	618
Oak	007, 019
Panasonic	000, 021, 107
Paragon	000
Philips	153
Pioneer	144, 533
Popular Mechanics	400
Prelude	770
Pulsar	000
Radio Shack	797
RCA	021
Recoton	400
Regal	020, 259, 273
Rembrandt	011
Runco	000
Samsung	040, 144
Scientific Atlanta	008, 017, 277
Signal	015, 040
Signature	011
SL Marx	040
Sprucer	021
Starcom	003, 015
Stargate	015, 040, 770
Starquest	015
Televue	040
Tocom	012, 013
Toshiba	000
Tusa	015
Unika	153
United Artists	007
United Cable	003
Universal	153
Zenith	000
Zentek	400

Manufacturers' codes for satellite tuner

AlphaStar	772
Echostar	775
General Instrument	361
HTS	775
Hughes Network Systems	749
Jerrold	361
Panasonic	701
Primestar	361
RCA	566
Sony	639

Manufacturers' codes for VCR

Admiral	048
Adventura	000
Aiko	278
Aiwa	000
Akai	041
American High	035
Asha	240
Audiovox	037
Beaumarck	240
Bell & Howell	104
Broksonic	121, 184, 211
Calix	037
Canon	035
Capehart	020
Carver	081
CCE	072, 278
Citizen	037, 278
Colt	072
Craig	037, 047, 072, 240
Curtis Mathes	035, 041, 060
Cybernex	240
Daewoo	020, 045, 278
Daytron	020
Dynatech	000
Electrohome	037
Electrophonic	037
Emerex	032
Emerson	000, 002, 037, 043, 121, 184, 211, 212, 278, 479
Fisher	047, 054, 104
Fuji	033, 035
Funai	000
Garrard	000
GE	035, 060
GoldStar	037, 038
Gradiente	000
Harley Davidson	000
Harman/Kardon	038
Harwood	072
Headquarter	046

HI-Q	047
Hitachi	041, 042, 105
Jensen	041
JVC	008, 041, 067
KEC	037, 278
Kenwood	038, 041, 067
KLH	072
Kodak	035, 037
Lloyd	000
Logik	072
LXI	037
Magnavox	035, 039, 081, 149
Magnin	240
Marantz	035, 081
Marta	037
Matsushita	035, 162
MEI	035
Memorex	000, 035, 037, 039, 046, 047, 048, 104, 240
MGA	043
MGN Technology	240
Minolta	042, 105
Mitsubishi	043, 067
Motorola	035, 048
MTC	000, 240
Multitech	000, 072
NEC	038, 041, 067, 104
Nikko	037
Nikon	034
Noblex	240
Olympus	035
Optimus	037, 048, 104, 162
Optonica	062
Orion	479
Panasonic	035, 162, 225
Penney	035, 037, 038, 042, 054, 240
Pentax	042, 105
Philco	035
Philips	035, 062, 081
Pilot	037
Pioneer	067
Portland	020
Profitronic	240
Protec	072
Pulsar	039
Quarter	046
Quartz	046
Quasar	035, 162
Radio Shack	000, 037
Radix	037
Randex	037
RCA	042, 060, 105, 149
Realistic	000, 035, 037, 046, 047, 048, 062, 104
Ricoh	034
Runco	039
Samsung	045, 240

Sanky	039, 048
Sansui	041, 067
Sanyo	046, 047, 104, 240
Scott	043, 045, 121, 184, 211, 212
Sears	035, 037, 042, 046, 047, 054, 104, 105
Sharp	048, 062
Shintom	072
Shogun	240
Singer	072
Sony	032, 033, 034, 035
STS	042
Sylvania	000, 035, 043, 081
Symphonic	000
Tatung	041
Teac	000, 041
Technics	035, 162
Teknika	000, 035, 037
TMK	240
Toshiba	043, 045, 212
Totevision	037, 240
Unitech	240
Vector	045
Vector Research	038
Video Concepts	045
Videosonic	240
Wards	000, 035, 042, 047, 048, 060, 062, 072, 149, 212, 240
XR-1000	000, 035, 072
Yamaha	038
Zenith	033, 034, 039

Manufacturers' codes listed on page 42 to 45 are subject to change without notice. If they are changed, this remote control cannot operate the equipment.

Troubleshooting

Use this chart to help you solve daily operational problems. If there is any problem you cannot solve, contact your JVC service center.

PROBLEM	POSSIBLE CAUSE	SOLUTION
The display does not light up.	The power cord is not plugged in.	Plug the power cord into an AC outlet.
No sound from speakers.	Speaker signal cables are not connected.	Check speaker wiring and reconnect if necessary.
	The SPEAKERS 1 and 2 buttons are not set correctly.	Press SPEAKERS 1 and 2 correctly.
	An incorrect source is selected.	Select the correct source.
	Mute is activated.	Press MUTE to cancel the mute.
Sound from one speaker only.	Speaker signal cables are not connected properly.	Check speaker wiring and reconnect if necessary.
	The balance is set to one extreme.	Adjust the balance properly.
Continuous hiss or buzzing during FM reception.	Incoming signal is too weak.	Connect an outside FM antenna or contact your dealer.
	The station is too far away.	Select a new station.
	An incorrect antenna is used.	Check with your dealer to be sure you have a correct antenna.
	Antennas are not connected properly.	Check connections.
Occasional cracking noise during FM reception.	Ignition noise from automobiles.	Move the antenna farther from automobile traffic.
No colors on the on-screen display.	The color system of the connected TV is not NTSC.	Connect an NTSC TV.
Howling during record playing.	Your turntable is too close to speakers.	Move speakers away from the turntable.
Remote control does not work.	The remote control mode selector is not set correctly.	Set the selector correctly either to the "AUDIO/TV/VCR" position or to "CATV/SAT" position.
	There is an obstruction in front of the remote control sensor on the receiver.	Remove the obstruction.
	Batteries are weak.	Replace batteries.

Specifications

Amplifier

Output Power	At Stereo operation	110 watts per channel, min. RMS, both channels driven into 8 ohms, 20 Hz to 20 kHz with no more than 0.06 % total harmonic distortion.
	At Surround operation	
	Front Channels	110 watts per channel, min. RMS, driven into 8 ohms at 1 kHz with no more than 0.8 % total harmonic distortion.
	Center channel	110 watts, min. RMS, driven into 8 ohms at 1 kHz, with no more than 0.8 % total harmonic distortion.
	Rear channels	110 watts, min. RMS, driven into 8 ohms at 1 kHz, with no more than 0.8 % total harmonic distortion.
Total Harmonic Distortion (8 ohms, 1 kHz)		0.06 %* at 110 watts output (* Measured by JVC Audio Analysis System)
Audio Input Sensitivity/ Impedance (1 kHz)	PHONO (MM) CD, TAPE, TV SOUND, VCR, VIDEO	2.5 mV/47 k ohms 230 mV/47 k ohms
Audio Output Level	TAPE, VCR	230 mV
Signal-to-Noise Ratio (* 66 IHF/78 IHF)	PHONO CD, TAPE, TV SOUND, VCR, VIDEO	70 dB/78 dB (at REC OUT) 87 dB/80 dB
Frequency Response (8 ohms)	PHONO CD, TAPE, TV SOUND, VCR, VIDEO	20 Hz to 20 kHz (± 1 dB) 20 Hz to 20 kHz (± 1 dB)
RIAA Phono Equalization		± 0.5 dB (20 Hz to 20 kHz)
Loudness Control (Volume Control at -40 dB)		+6 ± 1 dB at 100 Hz +4 ± 1 dB at 10 kHz
S.E.A.	Center Frequencies Control Range	100 Hz, 1 kHz, 10 kHz ± 10 dB ± 2 dB

Video

Video Input Sensitivity/Impedance	VCR, VIDEO	1 Vp-p/75 ohms
Video Output Level	VCR, MONITOR OUT	1 Vp-p/75 ohms
Synchronization		Negative
Signal-to-Noise Ratio		45 dB
On-Screen Color System		NTSC

FM tuner (IHF)

Tuning Range		87.5 MHz to 108.0 MHz
Usable Sensitivity	Monaural	10.8 dBf (0.95 μ V/75 ohms)
50 dB Quieting Sensitivity	Monaural	16.3 dBf (1.8 μ V/75 ohms)
	Stereo	38.3 dBf (22.5 μ V/75 ohms)
Signal-to-Noise Ratio (IHF-A weighted)	Monaural	80 dB at 85 dBf
	Stereo	73 dB at 85 dBf
Total Harmonic Distortion	Monaural	0.15 % at 1 kHz
	Stereo	0.2 % at 1 kHz
Stereo Separation at REC OUT		40 dB at 1 kHz
Capture Ratio		1.5 dB (10 mV)
Alternate Channel Selectivity		60 dB: (\pm 400 kHz)
Frequency Response		30 Hz to 15 kHz: (+0.5 dB, -3 dB)

AM tuner

Tuning Range		530 kHz to 1,710 kHz
Usable Sensitivity	Loop antenna	300 μ V/m
	External antenna	30 μ V
Signal-to-Noise Ratio		50 dB (100 mV/m)

General

Power Requirements		AC 120V [~] , 60 Hz
Power Consumption		300 watts/400 VA
		2 watts (in standby mode)
Dimensions (W x H x D)		17 ³ / ₁₆ x 6 ³ / ₁₆ x 16 ¹ / ₄ inches (435 x 156.5 x 412 mm)
Mass		22.3 lbs (10.1 kg)

Designs & specifications are subject to change without notice.

HOW TO LOCATE YOUR JVC SERVICE CENTER

TOLL FREE : 1-800-537-5722

Dear customer:

In order to receive the most satisfaction from your purchase, read the instruction booklet before operating the unit. In the event that repair is necessary, or for the address nearest your location, please refer to the factory service center list below or within the Continental United States, Call 1-800-537—5722 for your authorized servicer. Remember to retain you Bill of Sale for Warranty Service.

—JVC

JVC SERVICE & ENGINEERING COMPANY OF AMERICA DIVISION OF US JVC CORP.

FACTORY SERVICE CENTER LOCATIONS

107 Little Falls Road
Fairfield, NJ 07004-2105
(201) 808-9279

1500 Lakes Parkway
Lawrenceville, GA 30243-5357
(404) 339-2522

705 Enterprise Street
Aurora, IL 60504-8149
(708) 851-7855

5665 Corporate Avenue
Cypress, CA 90630-0024
(714) 229-8011

2969 Mapunapuna Place
Honolulu, HI 96819-2040
(808) 833-5828

10700 Hammerly, Suite 110
Houston, TX 77043
(713) 935-9331

230 Eliot Street
Ashland, MA 0172-2377
(508) 881-5923

14505 Commerce Way
Miami Lakes, FL 33016-1512
(305) 362-6252

890 Dubuque Avenue
South San Francisco, CA 94080-1804
(415) 871-2666

Sophisticated electronic products may require occasional service. Just as quality is a keyword in the engineering and production of the wide array of JVC products, service is the key to maintaining the high level of performance for which JVC is world famous. The JVC service and engineering organization stands behind our products.

NATIONAL HEADQUARTERS
JVC SERVICE & ENGINEERING COMPANY OF AMERICA
DIVISION OF US JVC CORP.
107 Little Falls Road
Fairfield, NJ 07004-2105

If you ship the product •••

Pack your JVC unit in the original carton or one of equivalent size and strength. Enclose, with the unit, a letter stating the problem or symptom that exists and also a copy of the receipt or bill of sale you received when you purchased your JVC unit. Print your home return address on the outside and the inside of the carton. Send to the appropriate JVC Factory Service Center as listed above.

Don't service it yourself.

CAUTION

*To prevent electrical shock, do not open the cabinet. No user serviceable parts inside.
Refer servicing to qualified service personnel.*

ACCESSORIES

*To purchase accessories for your JVC product, you may contact your local JVC Dealer.
Or from the 48 Continental United States call toll free : 800-882-2345*



LIMITED WARRANTY AUDIO-2

JVC COMPANY OF AMERICA warrants this product and all parts thereof, except as set forth below ONLY TO THE ORIGINAL PURCHASER AT RETAIL to be FREE FROM DEFECTIVE MATERIAL AND WORKMANSHIP from the date of original retail purchase for the period as shown below. ("The Warranty Period.")

PARTS 2 YRS	LABOR 2 YRS
----------------	----------------

THIS LIMITED WARRANTY IS VALID ONLY IN THE FIFTY(50) UNITED STATES, THE DISTRICT OF COLUMBIA AND IN COMMONWEALTH OF PUERTO RICO.

WHAT WE WILL DO:

If this product is found to be defective, JVC will repair or replace defective parts at no charge to the original owner. Such repair and replacement services shall be rendered by JVC during normal business hours at JVC authorized service centers. Parts used for replacement are warranted only for the remainder of the Warranty Period. All products and parts thereof may be brought to a JVC authorized service center on a carry-in basis except for Television sets having a screen size 25 inches and above which are covered on an in-home basis.

WHAT YOU MUST DO FOR WARRANTY SERVICE:

Return your product to a JVC authorized service center with a copy of your bill of sale. For your nearest JVC authorized service center, please call toll free: (800)537-5722. If service is not available locally, box the product carefully, preferably in the original carton, and ship, insured, with a copy of your bill of sale plus and letter of explanation of the problem to the nearest JVC Factory Service Center, the name and location of which will be given to you by the toll-free number. If you have any questions concerning your JVC Product, please contact our Customer Relations Department.

WHAT IS NOT COVERED:

This limited warranty provided by JVC does not cover:

1. Products which have been subject to abuse, accident, alteration, modification, tampering, negligence, misuse, faulty installation, lack of reasonable care, or if repaired or serviced by anyone other than a service facility authorized by JVC to render such service, or if affixed to any attachment not provided with the products, or if the model or serial number has been altered, tampered with, defaced or removed;
2. Initial installation and installation and removal for repair;
3. Operational adjustments covered in the Owner's Manual, normal maintenance, video and audio head cleaning;
4. Damage that occurs in shipment, due to act of God, and cosmetic damage;
5. Signal reception problems and failures due to line power surge;
6. Video Pick-up Tubes/CCD Image Sensor, Cartridge, Stylus(Needle) are covered for 90 days from the date of purchase;
7. Accessories;
8. Batteries (except the Rechargeable Batteries are covered for 90 days from the date of purchase);

There are no express warranties except as listed above.

THE DURATION OF ANY IMPLIED WARRANTIES, INCLUDING THE IMPLIED WARRANTY OF MERCHANTABILITY, IS LIMITED TO THE DURATION OF THE EXPRESS WARRANTY HEREIN.

JVC SHALL NOT BE LIABLE FOR THE LOSS OF USE THE PRODUCT, INCONVENIENCE, LOSS OR ANY OTHER DAMAGES, WHETHER DIRECT, INCIDENTAL OR CONSEQUENTIAL (INCLUDING, WITHOUT LIMITATION, DAMAGE TO TAPES, RECORDS OR DISCS) RESULTING FROM THE USE OF THIS PRODUCT, OR ARISING OUT OF ANY BREACH OF THIS WARRANTY. ALL EXPRESS AND IMPLIED WARRANTIES, INCLUDING THE WARRANTIES OF MERCHANTABILITY AND FITNESS FOR PARTICULAR PURPOSE, ARE LIMITED TO THE WARRANTY PERIOD SET FORTH ABOVE.

Some states do not allow the exclusion of incidental or consequential damages or limitations on how long an implied warranty last, so these limitations or exclusions may not apply to you. This warranty gives you specific legal rights and you may also have other rights which vary from state to state.

JVC COMPANY OF AMERICA
DIVISION OF US JVC CORP.

41 Slater Drive
Elmwood Park, New Jersey 07407

REFURBISHED PRODUCTS CARRY A SEPARATE WARRANTY, THIS WARRANTY DOES NOT APPLY. FOR DETAILS OF REFURBISHED PRODUCT WARRANTY, PLEASE REFER TO THE REFURBISHED PRODUCT WARRANTY INFORMATION PACKAGED WITH EACH REFURBISHED PRODUCT.

For customer use:

Enter below the Model No. and Serial No. which is located either on the rear, bottom or side of the cabinet. Retain this information for future reference.

Model No.: _____

Serial No.: _____

Purchase date: _____

Name of dealer: _____

